



CAD Details

Listed below are detailed drawings of the InSoFast Panel. These drawings are provided to assist you in designing or supplementing your existing drawings with the necessary InSoFast Panel details. These details are also available in dwg or dxf formats.

[InSoFast Panel Details](#) (Click Here)

Masonry Block CMU Details

- [Below Grade Details](#) (Click Here)
- [Above Grade Details](#) (Click Here)
- [Below & Above Grade Details](#) (Click Here)

Poured Concrete Wall Details

- [Above Grade Details](#) (Click Here)

Steel Framed Construction Details

- [Interior Details](#) (Click Here)
- [Exterior Details](#) (Click Here)

Wood Framed Construction Details

- [Interior Details](#) (Click Here)
- [Exterior Details](#) (Click Here)

[Ceiling Detail](#) (Click Here)

[Window & Door Details](#) (Click Here)

[Utilities Detail](#) (Click Here)

[Corner Bead Detail](#) (Click Here)

ISF 01.01 INSOFAST PANEL DETAILS

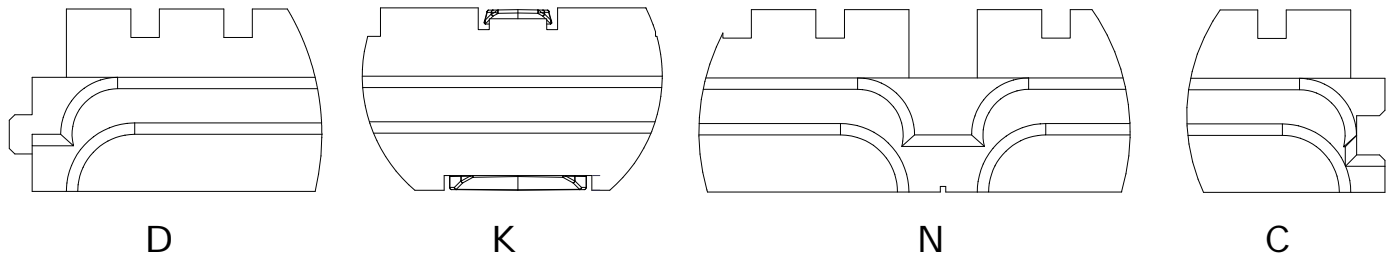
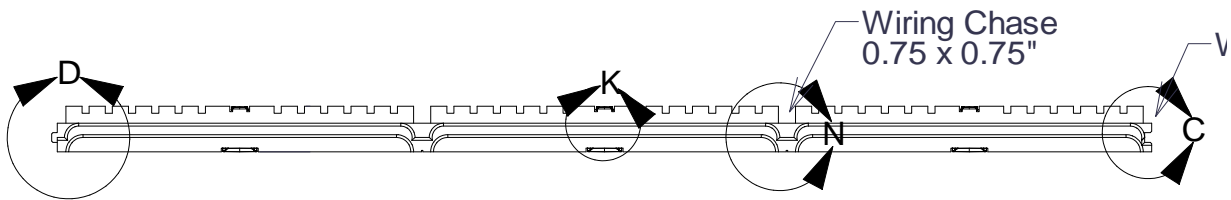
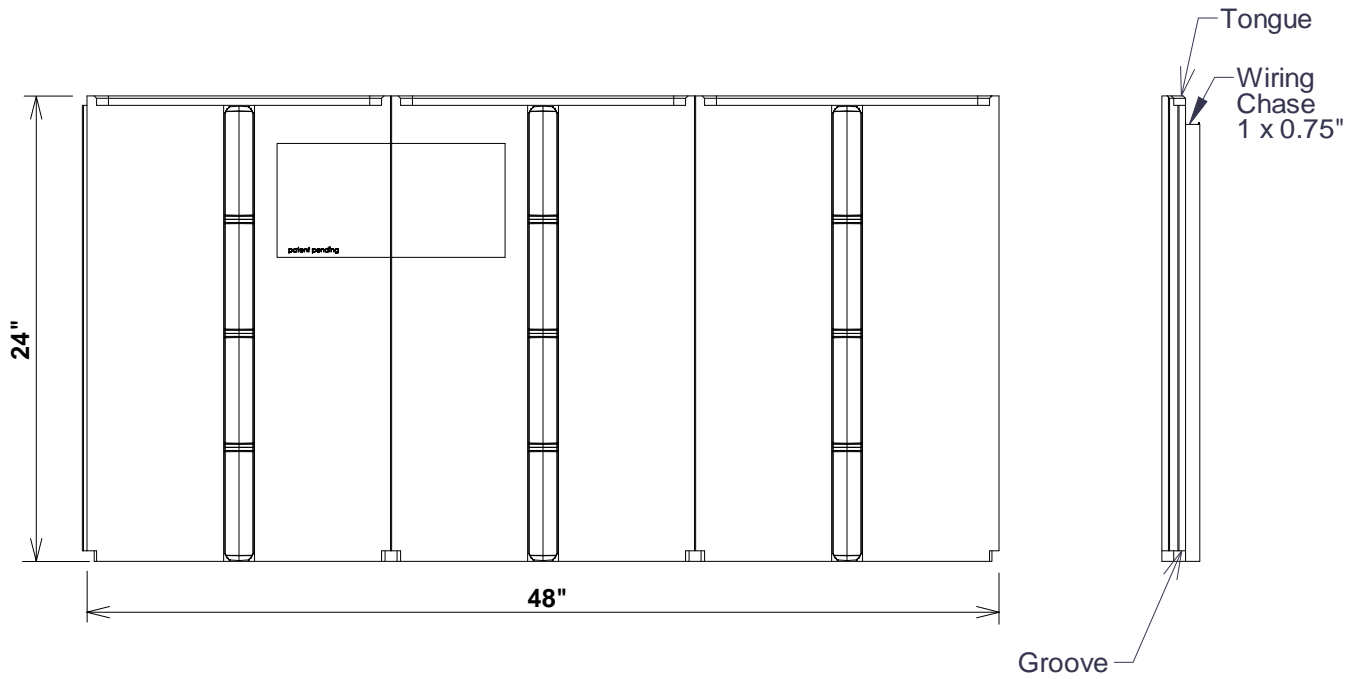

DUE TO VARIANCES IN LOCAL CODES, CONSTRUCTION PRACTICES, AND REQUIREMENTS, ALL DETAILS SHALL BE CONSTRUCTED IN ACCORDANCE WITH SUCH LOCAL CODES, CONSTRUCTION PRACTICES, AND REQUIREMENTS REGARDLESS OF DETAIL CONSTRUCTION SHOWN IN THIS DRAWING, INSOFAST, LLC MAKES NO WARRANTY, EXPRESSED OR IMPLIED. INSOFAST, LLC ASSUMES NO LEGAL LIABILITY OR RESPONSIBILITY FOR THE ACCURACY, COMPLETENESS, OR USEFULNESS OR ANY INFORMATION APPARATUS, PRODUCT OR PROCESS DISCLOSED.



InSoFast Panel Details

888-501-7899

InSoFast, LLC

www.InSoFast.com

Scale: NOT TO SCALE

Date: March 2010

Detail #: **ISF 01.01**

ISF 01.02 INSOFAST PANEL - ISOMETRIC VIEW

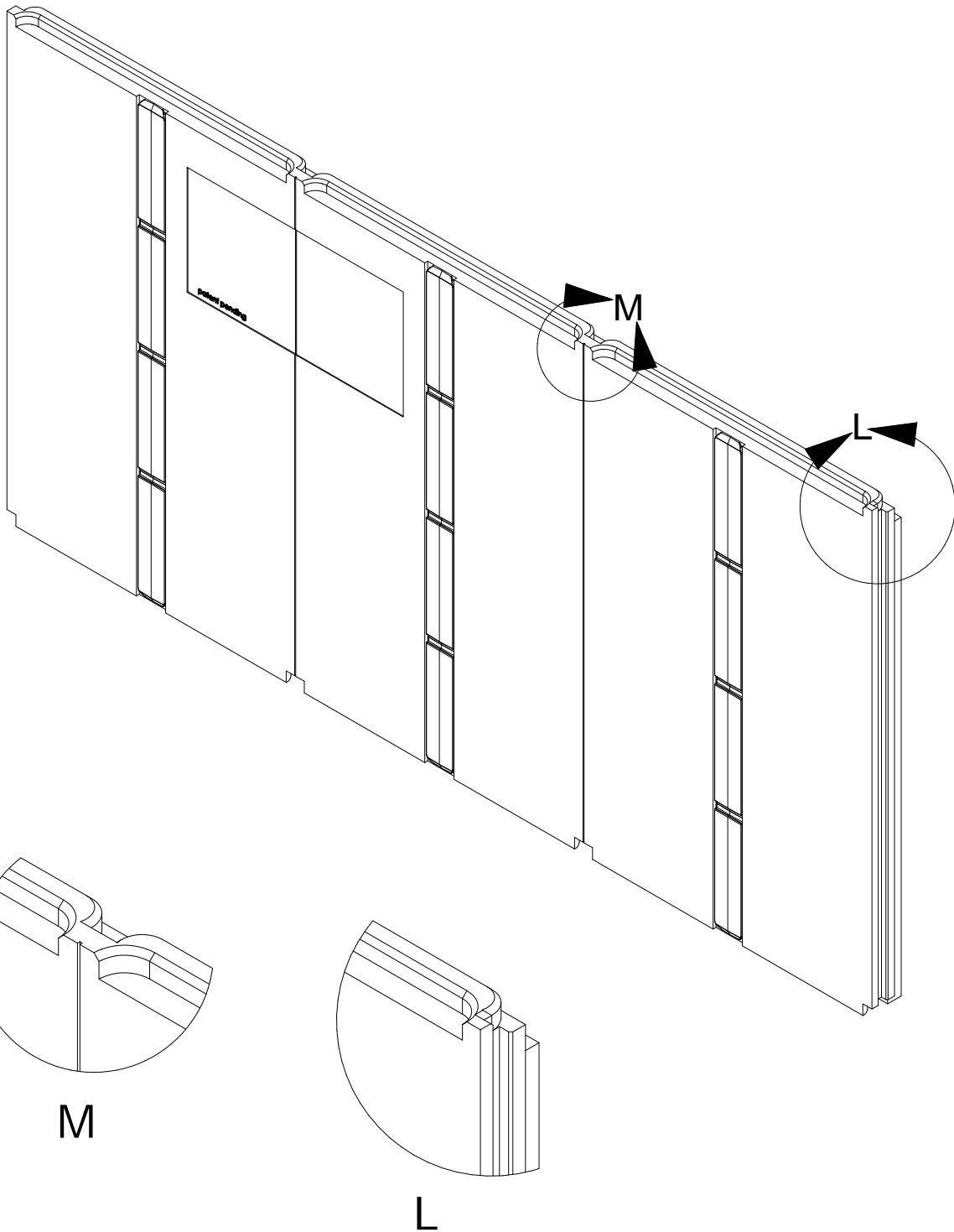

DUE TO VARIANCES IN LOCAL CODES, CONSTRUCTION PRACTICES, AND REQUIREMENTS, ALL DETAILS SHALL BE CONSTRUCTED IN ACCORDANCE WITH SUCH LOCAL CODES, CONSTRUCTION PRACTICES, AND REQUIREMENTS REGARDLESS OF DETAIL CONSTRUCTION SHOWN IN THIS DRAWING, INSOFAST, LLC MAKES NO WARRANTY, EXPRESSED OR IMPLIED. INSOFAST, LLC ASSUMES NO LEGAL LIABILITY OR RESPONSIBILITY FOR THE ACCURACY, COMPLETENESS, OR USEFULNESS OR ANY INFORMATION APPARATUS, PRODUCT OR PROCESS DISCLOSED.



InSoFast Panel - Isometric View

888-501-7899

InSoFast, LLC

www.InSoFast.com

Scale: NOT TO SCALE

Date: March 2010

Detail #: **ISF 01.02**

ISF 01.03 INSOFAST STUD

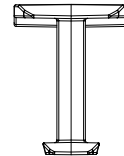
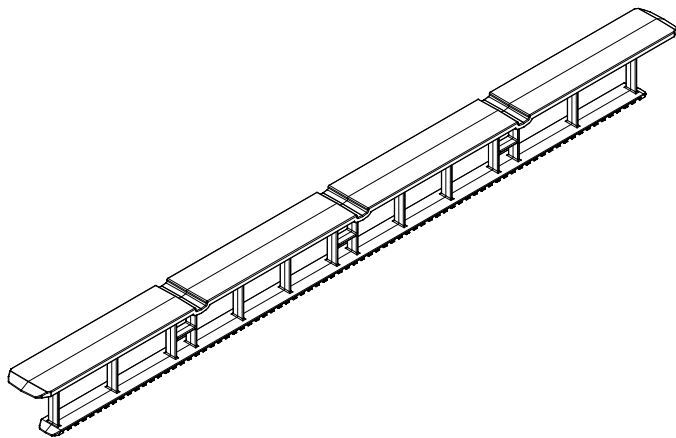
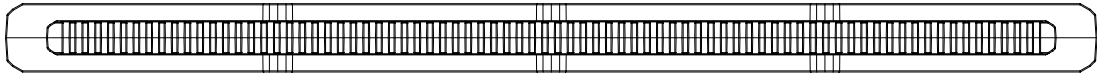
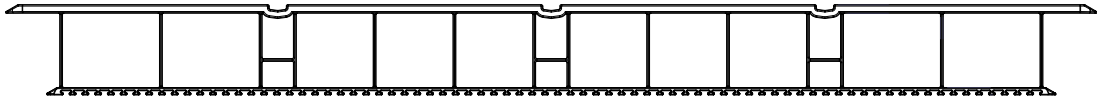

DUE TO VARIANCES IN LOCAL CODES, CONSTRUCTION PRACTICES, AND REQUIREMENTS, ALL DETAILS SHALL BE CONSTRUCTED IN ACCORDANCE WITH SUCH LOCAL CODES, CONSTRUCTION PRACTICES, AND REQUIREMENTS REGARDLESS OF DETAIL CONSTRUCTION SHOWN IN THIS DRAWING, INSOFAST, LLC MAKES NO WARRANTY, EXPRESSED OR IMPLIED. INSOFAST, LLC ASSUMES NO LEGAL LIABILITY OR RESPONSIBILITY FOR THE ACCURACY, COMPLETENESS, OR USEFULNESS OR ANY INFORMATION APPARATUS, PRODUCT OR PROCESS DISCLOSED.



InSoFast Stud

888-501-7899

InSoFast, LLC

www.InSoFast.com

Scale: NOT TO SCALE

Date: March 2010

Detail #: **ISF 01.03**

ISF 02.01.01 INSOFast - CMU MASONRY - BASEMENT - INTERIOR

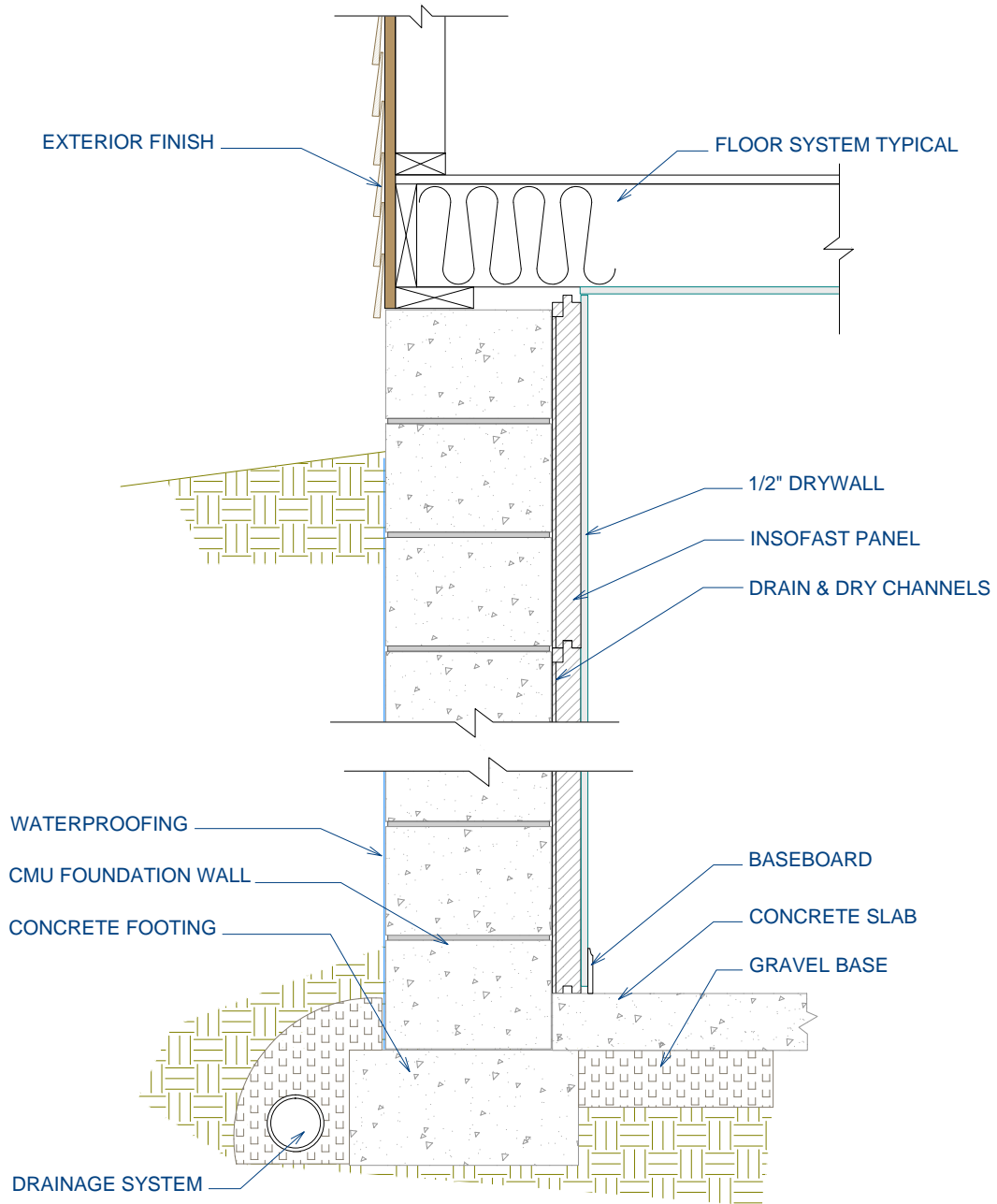

DUE TO VARIANCES IN LOCAL CODES, CONSTRUCTION PRACTICES, AND REQUIREMENTS, ALL DETAILS SHALL BE CONSTRUCTED IN ACCORDANCE WITH SUCH LOCAL CODES, CONSTRUCTION PRACTICES, AND REQUIREMENTS REGARDLESS OF DETAIL CONSTRUCTION SHOWN IN THIS DRAWING, INSOFast, LLC MAKES NO WARRANTY, EXPRESSED OR IMPLIED. INSOFast, LLC ASSUMES NO LEGAL LIABILITY OR RESPONSIBILITY FOR THE ACCURACY, COMPLETENESS, OR USEFULNESS OR ANY INFORMATION APPARATUS, PRODUCT OR PROCESS DISCLOSED.



CMU Masonry - Below Grade - Interior

888-501-7899

InSoFast, LLC

www.InSoFast.com

Scale: NOT TO SCALE

Date: March 2010

Detail #: **ISF 02.01.01**

ISF 02.01.02 INSOFAST - CMU MASONRY - BASEMENT - INTERIOR - INTERIOR DRAINAGE

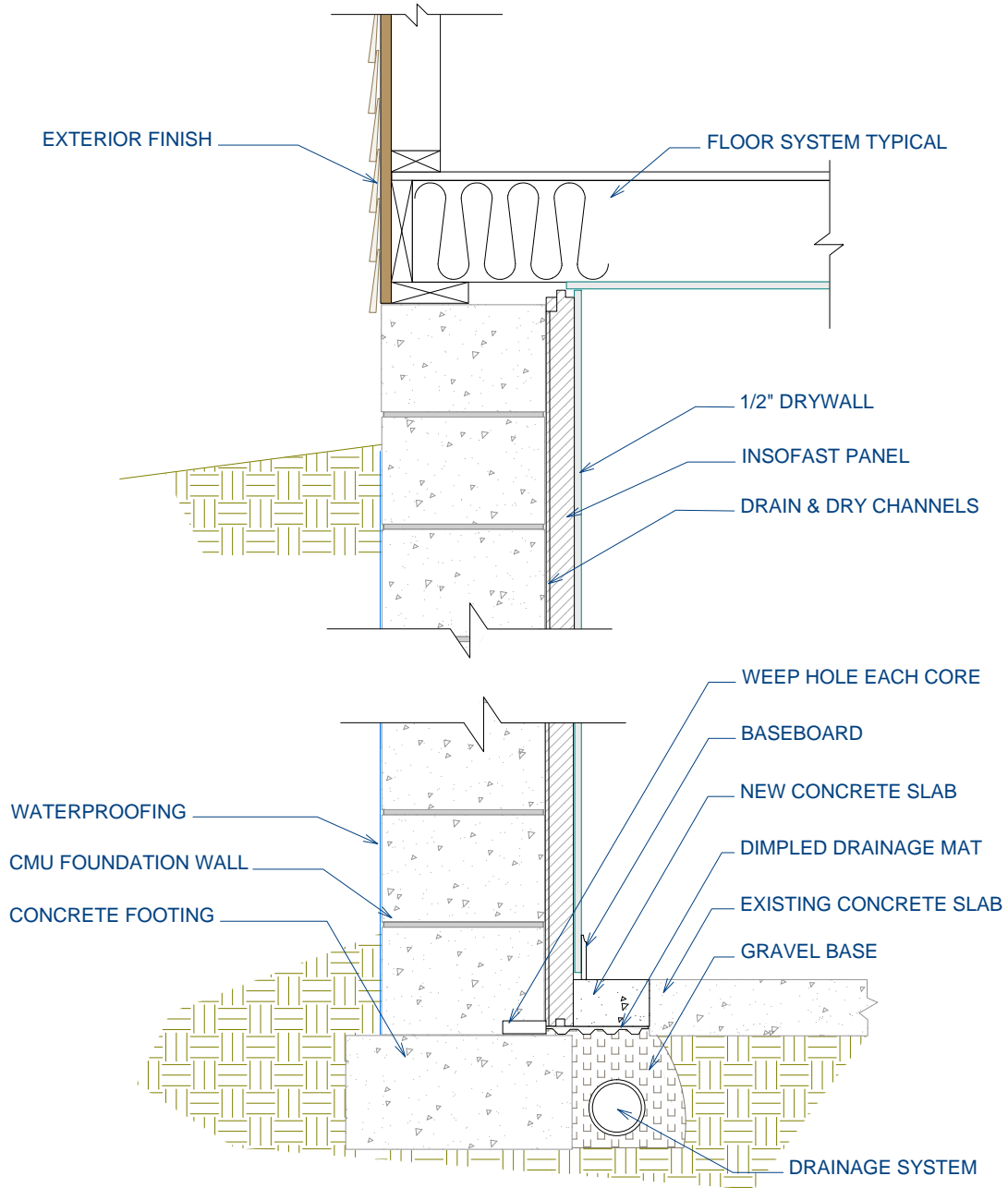

DUE TO VARIANCES IN LOCAL CODES, CONSTRUCTION PRACTICES, AND REQUIREMENTS, ALL DETAILS SHALL BE CONSTRUCTED IN ACCORDANCE WITH SUCH LOCAL CODES, CONSTRUCTION PRACTICES, AND REQUIREMENTS REGARDLESS OF DETAIL CONSTRUCTION SHOWN IN THIS DRAWING, INSOFAST, LLC MAKES NO WARRANTY, EXPRESSED OR IMPLIED. INSOFAST, LLC ASSUMES NO LEGAL LIABILITY OR RESPONSIBILITY FOR THE ACCURACY, COMPLETENESS, OR USEFULNESS OR ANY INFORMATION APPARATUS, PRODUCT OR PROCESS DISCLOSED.



CMU Masonry - Below Grade - Interior - Interior Drainage

888-501-7899

InSoFast, LLC

www.InSoFast.com

Scale: NOT TO SCALE

Date: March 2010

Detail #: **ISF 02.01.02**

**ISF 02.01.03 INSOFAST - CMU MASONRY - BASEMENT - INTERIOR
PERIMETER DRAINAGE**

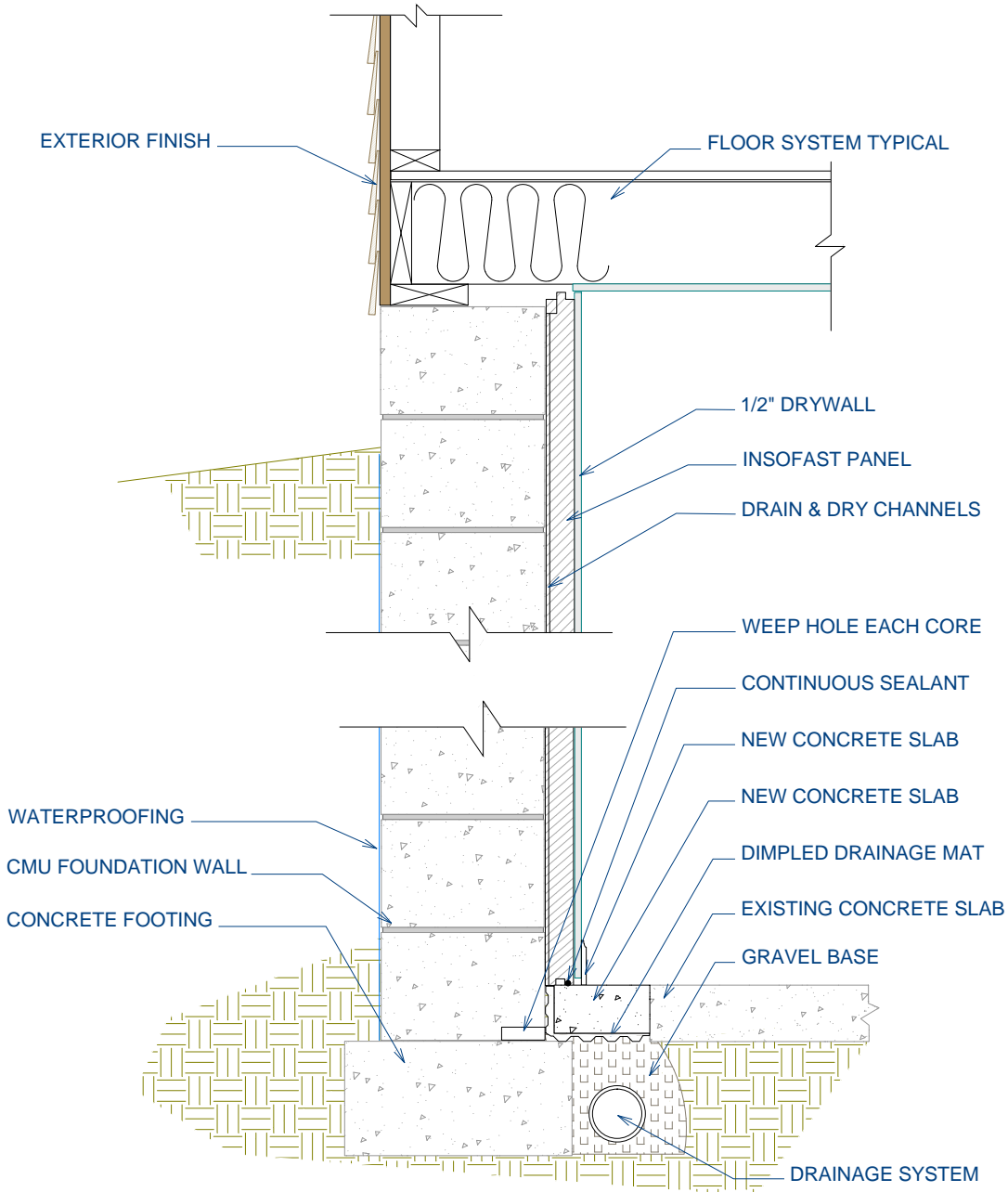

DUE TO VARIANCES IN LOCAL CODES, CONSTRUCTION PRACTICES, AND REQUIREMENTS, ALL DETAILS SHALL BE CONSTRUCTED IN ACCORDANCE WITH SUCH LOCAL CODES, CONSTRUCTION PRACTICES, AND REQUIREMENTS REGARDLESS OF DETAIL CONSTRUCTION SHOWN IN THIS DRAWING, INSOFAST, LLC MAKES NO WARRANTY, EXPRESSED OR IMPLIED. INSOFAST, LLC ASSUMES NO LEGAL LIABILITY OR RESPONSIBILITY FOR THE ACCURACY, COMPLETENESS, OR USEFULNESS OR ANY INFORMATION APPARATUS, PRODUCT OR PROCESS DISCLOSED.



CMU Masonry - Below Grade - Interior - Perimeter Drainage

888-501-7899

InSoFast, LLC

www.InSoFast.com

Scale: NOT TO SCALE

Date: March 2010

Detail #: **ISF 02.01.03**

ISF 02.01.04 INSOFAST - CMU MASONRY - HALF BASEMENT - INTERIOR - LOOKOUT LEDGE

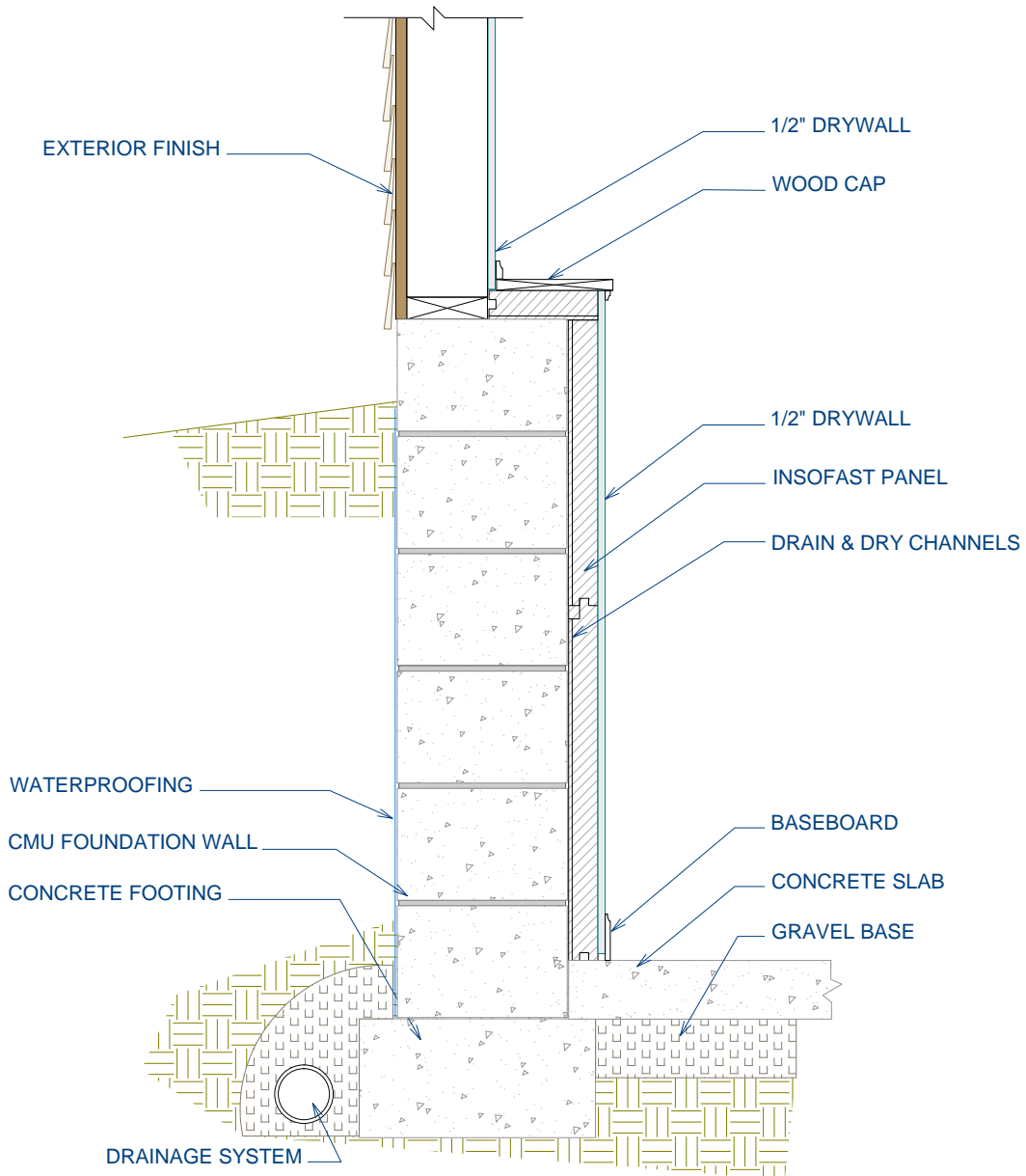

DUE TO VARIANCES IN LOCAL CODES, CONSTRUCTION PRACTICES, AND REQUIREMENTS, ALL DETAILS SHALL BE CONSTRUCTED IN ACCORDANCE WITH SUCH LOCAL CODES, CONSTRUCTION PRACTICES, AND REQUIREMENTS REGARDLESS OF DETAIL CONSTRUCTION SHOWN IN THIS DRAWING, INSOFAST, LLC MAKES NO WARRANTY, EXPRESSED OR IMPLIED. INSOFAST, LLC ASSUMES NO LEGAL LIABILITY OR RESPONSIBILITY FOR THE ACCURACY, COMPLETENESS, OR USEFULNESS OR ANY INFORMATION APPARATUS, PRODUCT OR PROCESS DISCLOSED.



CMU Masonry - Below Grade - Interior - Lookout Ledge

888-501-7899

InSoFast, LLC

www.InSoFast.com

Scale: NOT TO SCALE

Date: March 2010

Detail #: **ISF 02.01.04**

**ISF 02-01-11 INSOFAST - CMU MASONRY - BASEMENT - EXTERIOR -
TO START OF GRADE**

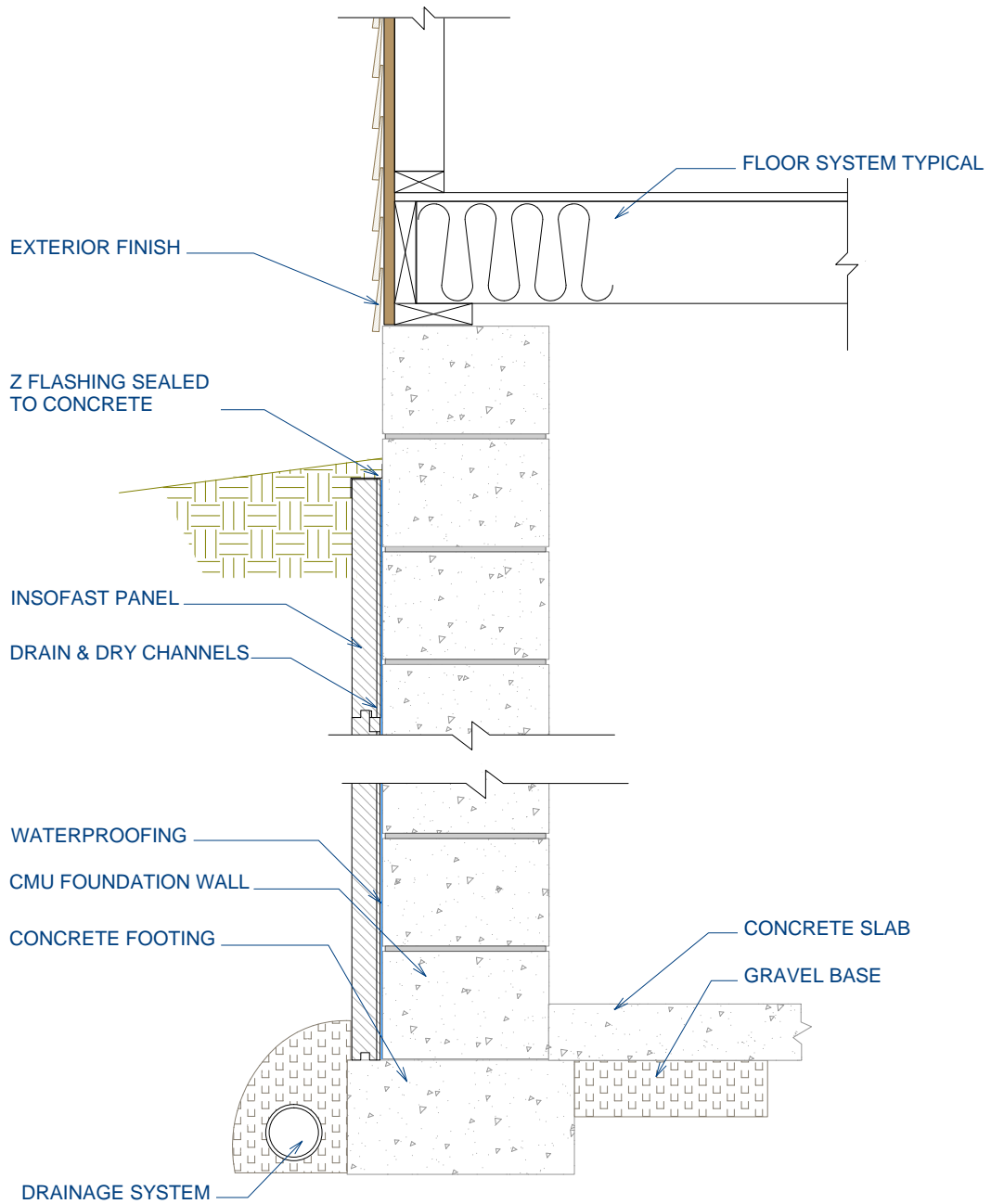

DUE TO VARIANCES IN LOCAL CODES, CONSTRUCTION PRACTICES, AND REQUIREMENTS, ALL DETAILS SHALL BE CONSTRUCTED IN ACCORDANCE WITH SUCH LOCAL CODES, CONSTRUCTION PRACTICES, AND REQUIREMENTS REGARDLESS OF DETAIL CONSTRUCTION SHOWN IN THIS DRAWING, INSOFAST, LLC MAKES NO WARRANTY, EXPRESSED OR IMPLIED. INSOFAST, LLC ASSUMES NO LEGAL LIABILITY OR RESPONSIBILITY FOR THE ACCURACY, COMPLETENESS, OR USEFULNESS OR ANY INFORMATION APPARATUS, PRODUCT OR PROCESS DISCLOSED.



CMU Masonry - Below Grade - Exterior - To Start of Grade

888-501-7899

InSoFast, LLC

www.InSoFast.com

Scale: NOT TO SCALE

Date: March 2010

Detail #: **ISF 02.01.11**

ISF 02.01.12 INSOFAST - CMU MASONRY - BASEMENT- EXTERIOR - TO START OF SIDING

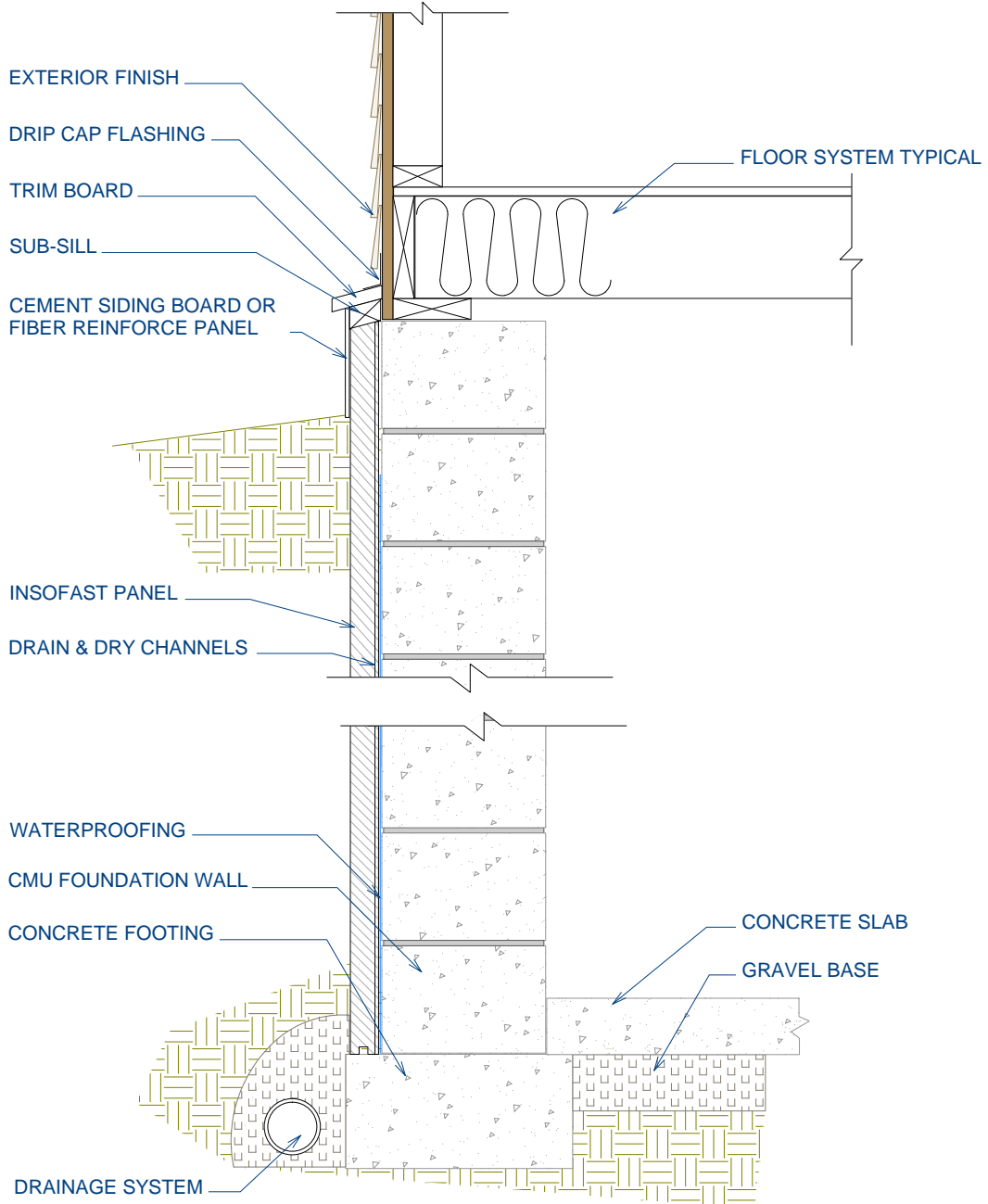

DUE TO VARIANCES IN LOCAL CODES, CONSTRUCTION PRACTICES, AND REQUIREMENTS, ALL DETAILS SHALL BE CONSTRUCTED IN ACCORDANCE WITH SUCH LOCAL CODES, CONSTRUCTION PRACTICES, AND REQUIREMENTS REGARDLESS OF DETAIL CONSTRUCTION SHOWN IN THIS DRAWING, INSOFAST, LLC MAKES NO WARRANTY, EXPRESSED OR IMPLIED. INSOFAST, LLC ASSUMES NO LEGAL LIABILITY OR RESPONSIBILITY FOR THE ACCURACY, COMPLETENESS, OR USEFULNESS OR ANY INFORMATION APPARATUS, PRODUCT OR PROCESS DISCLOSED.



CMU Masonry - Below Grade - Exterior - To Start of Siding
 888-501-7899 InSoFast, LLC www.InSoFast.com

Scale: NOT TO SCALE
 Date: March 2010
 Detail #: **ISF 02.01.12**

ISF 02.01.13 INSOFAST - CMU MASONRY - BASEMENT - EXTERIOR - TO START OF SIDING

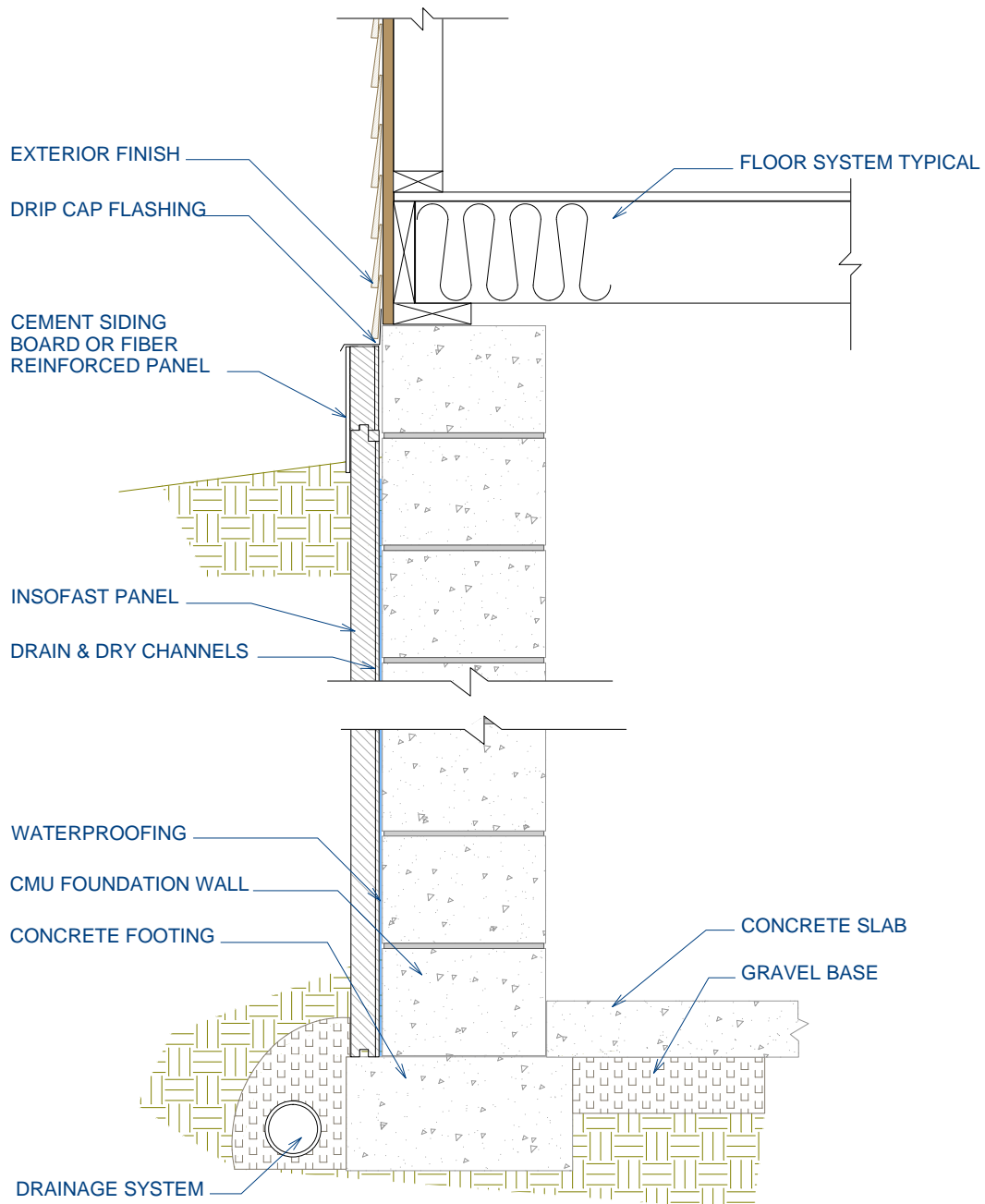

DUE TO VARIANCES IN LOCAL CODES, CONSTRUCTION PRACTICES, AND REQUIREMENTS, ALL DETAILS SHALL BE CONSTRUCTED IN ACCORDANCE WITH SUCH LOCAL CODES, CONSTRUCTION PRACTICES, AND REQUIREMENTS REGARDLESS OF DETAIL CONSTRUCTION SHOWN IN THIS DRAWING, INSOFAST, LLC MAKES NO WARRANTY, EXPRESSED OR IMPLIED. INSOFAST, LLC ASSUMES NO LEGAL LIABILITY OR RESPONSIBILITY FOR THE ACCURACY, COMPLETENESS, OR USEFULNESS OR ANY INFORMATION APPARATUS, PRODUCT OR PROCESS DISCLOSED.



CMU Masonry - Below Grade - Exterior - To Start of Siding

888-501-7899

InSoFast, LLC

www.InSoFast.com

Scale: NOT TO SCALE

Date: March 2010

Detail #: **ISF 02.01.13**

ISF 02.01.14 INSOFAST - CMU MASONRY - BASEMENT - EXTERIOR - NEW CONSTRUCTION

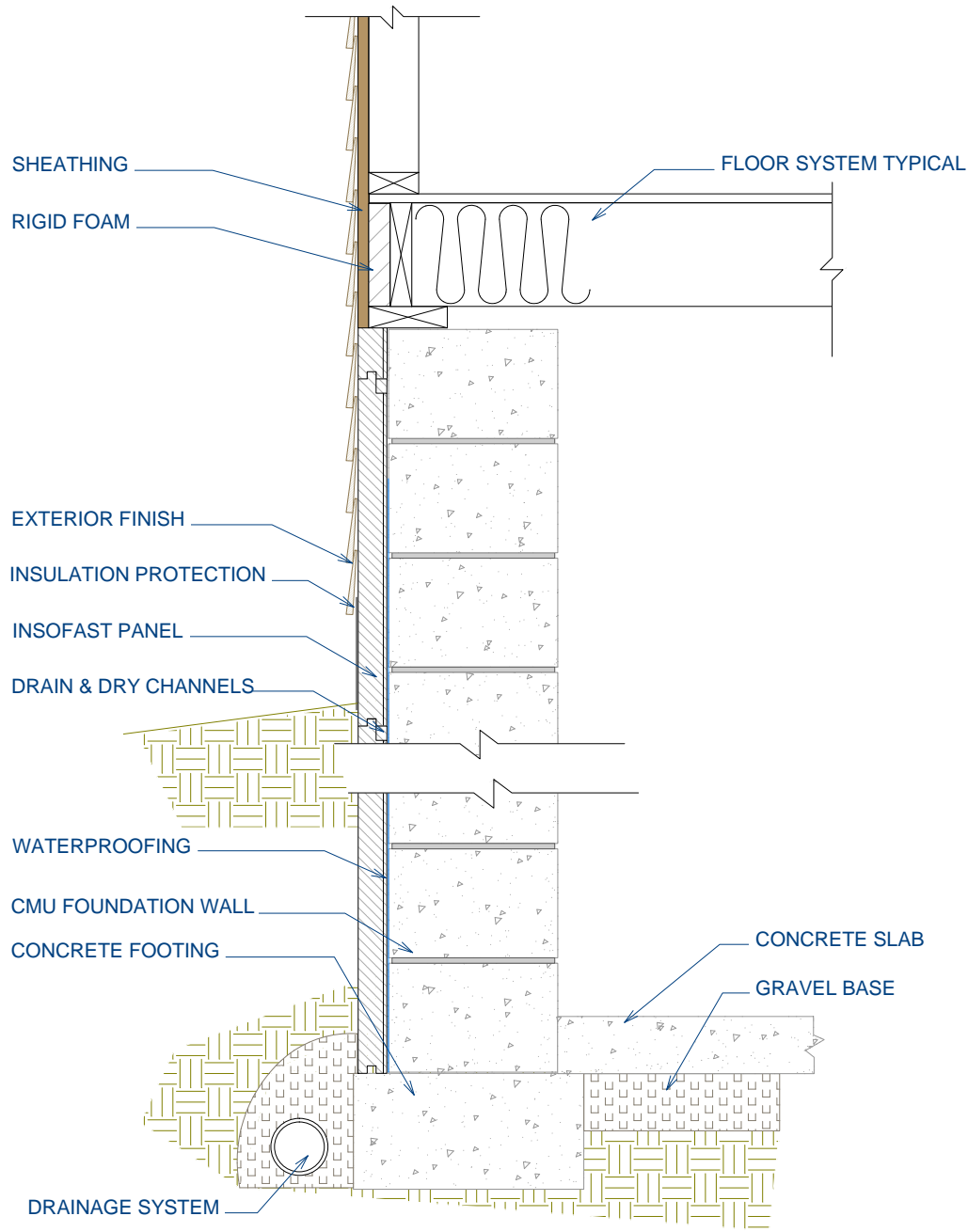

DUE TO VARIANCES IN LOCAL CODES, CONSTRUCTION PRACTICES, AND REQUIREMENTS, ALL DETAILS SHALL BE CONSTRUCTED IN ACCORDANCE WITH SUCH LOCAL CODES, CONSTRUCTION PRACTICES, AND REQUIREMENTS REGARDLESS OF DETAIL CONSTRUCTION SHOWN IN THIS DRAWING, INSOFAST, LLC MAKES NO WARRANTY, EXPRESSED OR IMPLIED. INSOFAST, LLC ASSUMES NO LEGAL LIABILITY OR RESPONSIBILITY FOR THE ACCURACY, COMPLETENESS, OR USEFULNESS OR ANY INFORMATION APPARATUS, PRODUCT OR PROCESS DISCLOSED.

	CMU Masonry - Below Grade - Exterior - New Construction			Scale: NOT TO SCALE
	888-501-7899	InSoFast, LLC	www.InSoFast.com	Date: March 2010
				Detail #: ISF 02.01.14

**ISF 02.01.15 INSOFAST - CMU MASONRY - BASEMENT - EXTERIOR -
MANUFACTURED STONE KNEE WALL**

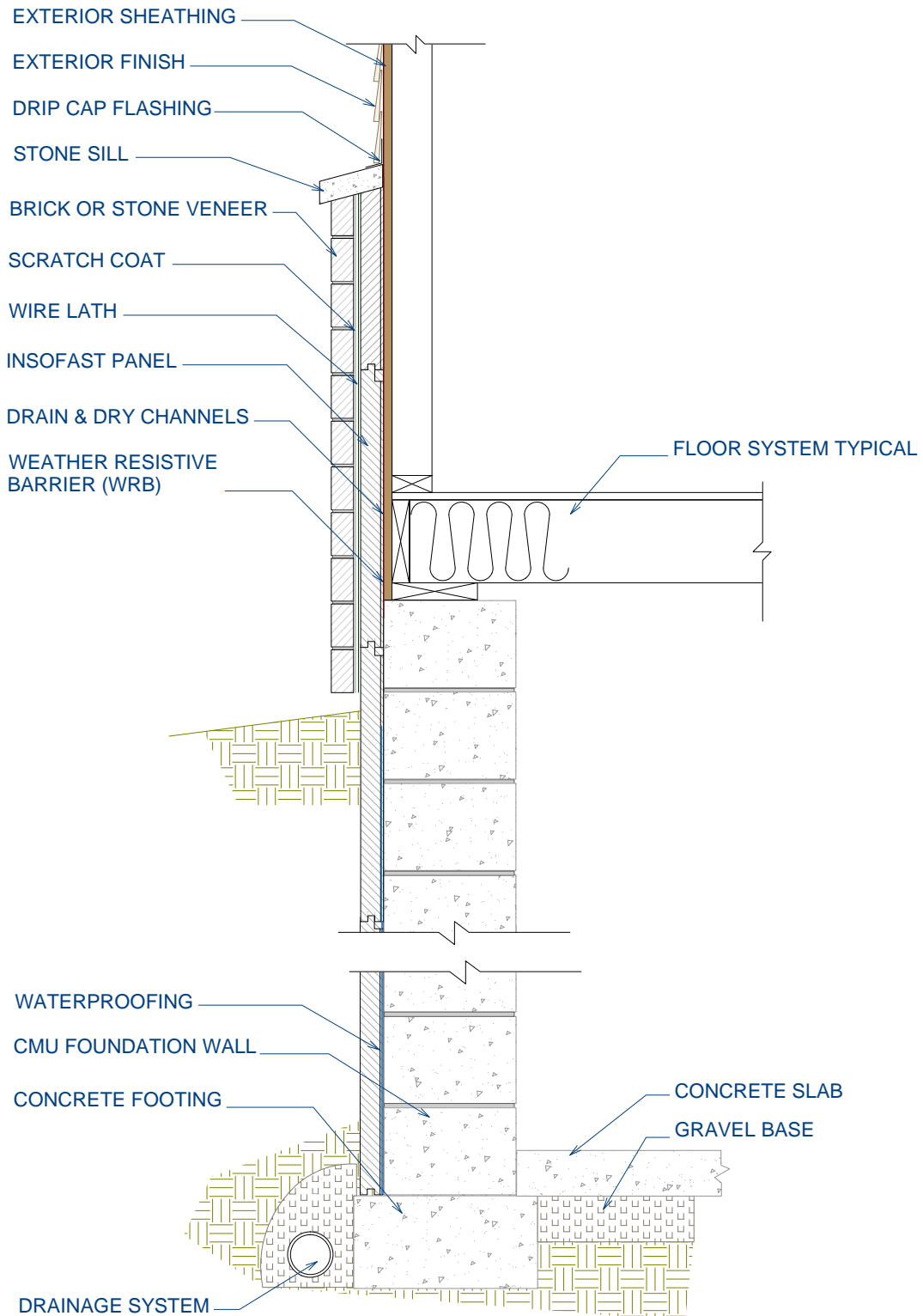

DUE TO VARIANCES IN LOCAL CODES, CONSTRUCTION PRACTICES, AND REQUIREMENTS, ALL DETAILS SHALL BE CONSTRUCTED IN ACCORDANCE WITH SUCH LOCAL CODES, CONSTRUCTION PRACTICES, AND REQUIREMENTS REGARDLESS OF DETAIL CONSTRUCTION SHOWN IN THIS DRAWING, INSOFAST, LLC MAKES NO WARRANTY, EXPRESSED OR IMPLIED. INSOFAST, LLC ASSUMES NO LEGAL LIABILITY OR RESPONSIBILITY FOR THE ACCURACY, COMPLETENESS, OR USEFULNESS OR ANY INFORMATION APPARATUS, PRODUCT OR PROCESS DISCLOSED.



CMU Masonry - Below Grade - Exterior - Manufactured Stone Knee Wall

888-501-7899

InSoFast, LLC

www.InSoFast.com

Scale: NOT TO SCALE

Date: March 2010

Detail #: **ISF 02.01.15**

ISF 02.01.21 INSOFAST - CMU MASONRY - BASEMENT - INTERIOR & EXTERIOR - TO START OF GRADE

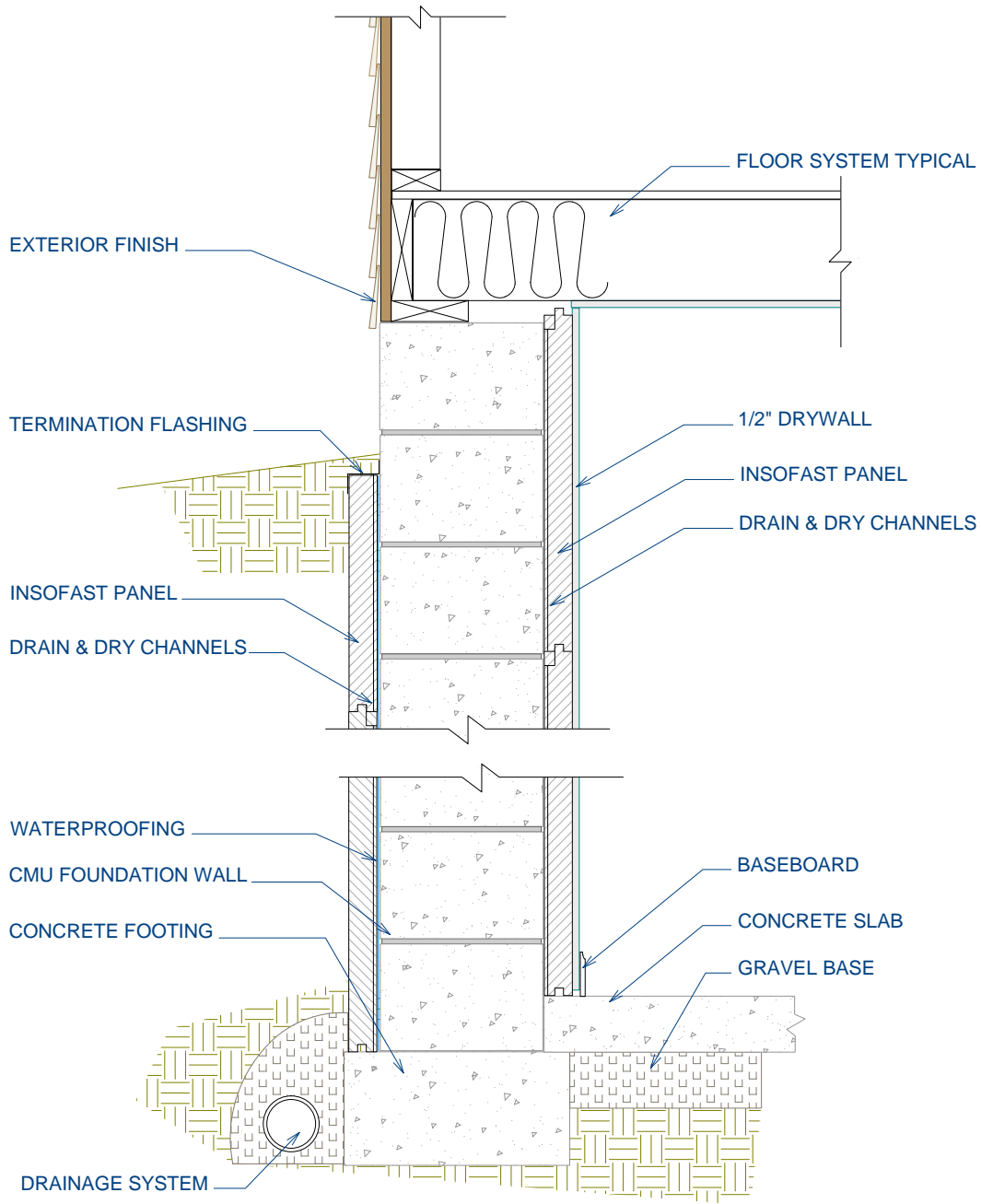

DUE TO VARIANCES IN LOCAL CODES, CONSTRUCTION PRACTICES, AND REQUIREMENTS, ALL DETAILS SHALL BE CONSTRUCTED IN ACCORDANCE WITH SUCH LOCAL CODES, CONSTRUCTION PRACTICES, AND REQUIREMENTS REGARDLESS OF DETAIL CONSTRUCTION SHOWN IN THIS DRAWING, INSOFAST, LLC MAKES NO WARRANTY, EXPRESSED OR IMPLIED. INSOFAST, LLC ASSUMES NO LEGAL LIABILITY OR RESPONSIBILITY FOR THE ACCURACY, COMPLETENESS, OR USEFULNESS OR ANY INFORMATION APPARATUS, PRODUCT OR PROCESS DISCLOSED.



CMU Masonry - Below Grade - Interior & Exterior - To Start of Grade

888-501-7899

InSoFast, LLC

www.InSoFast.com

Scale: NOT TO SCALE

Date: March 2010

Detail #: **ISF 02.01.21**

ISF 02.02.01 INSOFAST - CMU MASONRY - ABOVE GRADE - EXTERIOR - STANDARD WOOD FRAMING INTERIOR

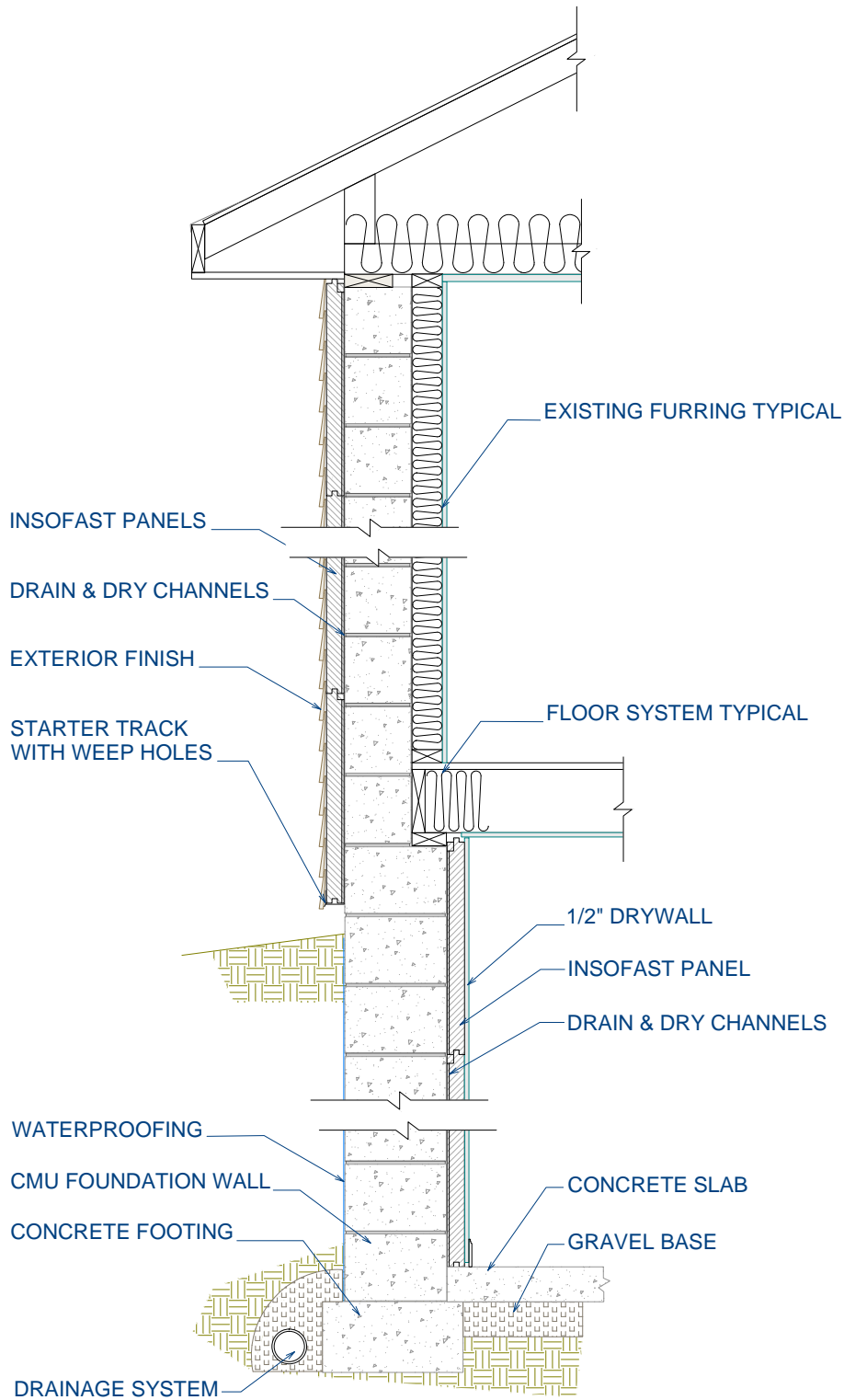

DUE TO VARIANCES IN LOCAL CODES, CONSTRUCTION PRACTICES, AND REQUIREMENTS, ALL DETAILS SHALL BE CONSTRUCTED IN ACCORDANCE WITH SUCH LOCAL CODES, CONSTRUCTION PRACTICES, AND REQUIREMENTS REGARDLESS OF DETAIL CONSTRUCTION SHOWN IN THIS DRAWING, INSOFAST, LLC MAKES NO WARRANTY, EXPRESSED OR IMPLIED. INSOFAST, LLC ASSUMES NO LEGAL LIABILITY OR RESPONSIBILITY FOR THE ACCURACY, COMPLETENESS, OR USEFULNESS OR ANY INFORMATION APPARATUS, PRODUCT OR PROCESS DISCLOSED.



CMU Masonry - Above Grade - Exterior - Standard Wood Framing Interior

888-501-7899

InSoFast, LLC

www.InSoFast.com

Scale: NOT TO SCALE

Date: March 2010

Detail #: **ISF 02.02.01**

ISF 02.02.02 INSOFAST - CMU MASONRY - ABOVE GRADE - EXTERIOR TO FROST LINE

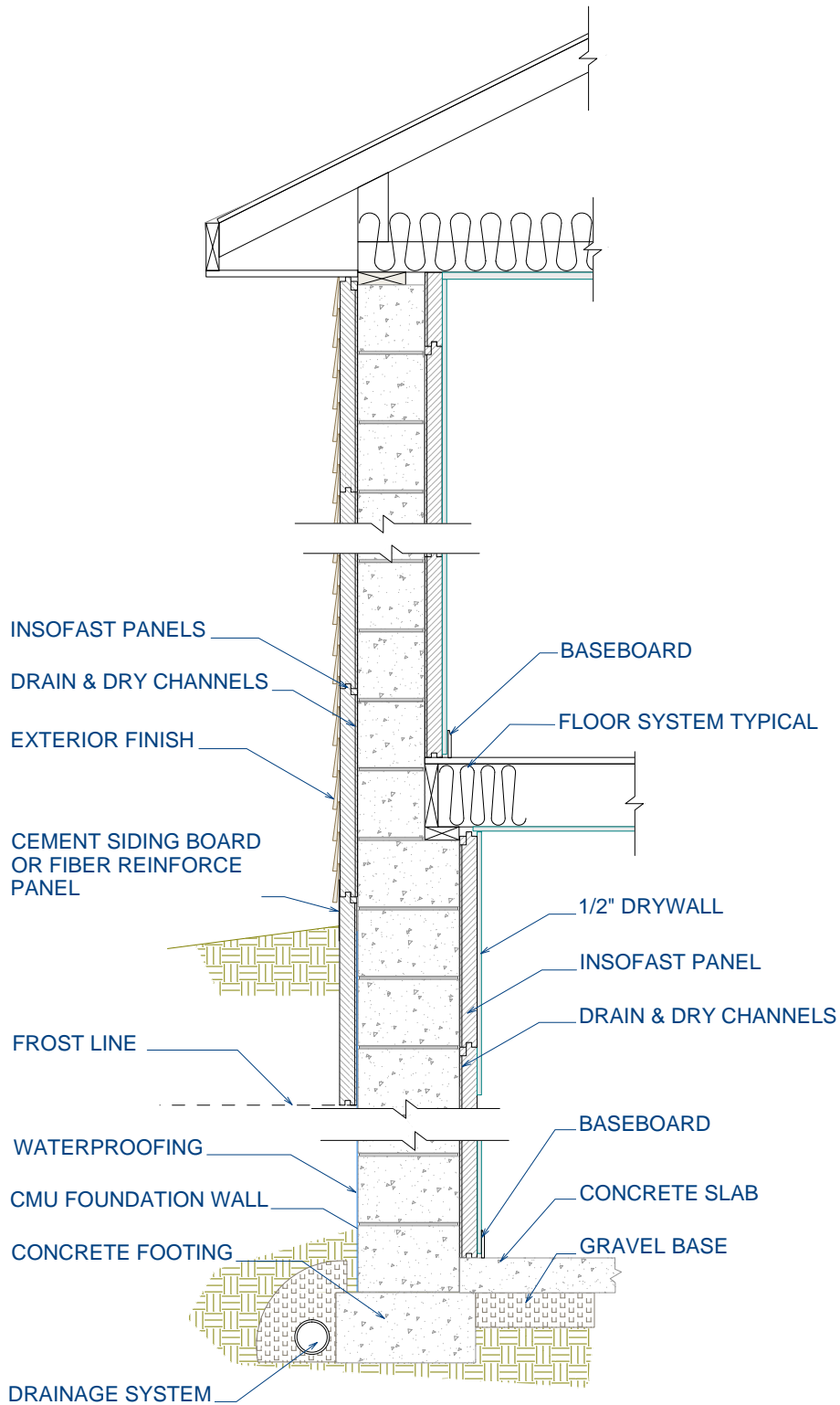

DUE TO VARIANCES IN LOCAL CODES, CONSTRUCTION PRACTICES, AND REQUIREMENTS, ALL DETAILS SHALL BE CONSTRUCTED IN ACCORDANCE WITH SUCH LOCAL CODES, CONSTRUCTION PRACTICES, AND REQUIREMENTS REGARDLESS OF DETAIL CONSTRUCTION SHOWN IN THIS DRAWING, INSOFAST, LLC MAKES NO WARRANTY, EXPRESSED OR IMPLIED. INSOFAST, LLC ASSUMES NO LEGAL LIABILITY OR RESPONSIBILITY FOR THE ACCURACY, COMPLETENESS, OR USEFULNESS OR ANY INFORMATION APPARATUS, PRODUCT OR PROCESS DISCLOSED.



CMU Masonry - Above Grade - Exterior to Frost Line

888-501-7899

InSoFast, LLC

www.InSoFast.com

Scale: NOT TO SCALE

Date: March 2010

Detail #: **ISF 02.02.02**

ISF 02.02.11 INSOFAST - CMU MASONRY - ABOVE GRADE - INTERIOR - STEEL BAR ROOF

L

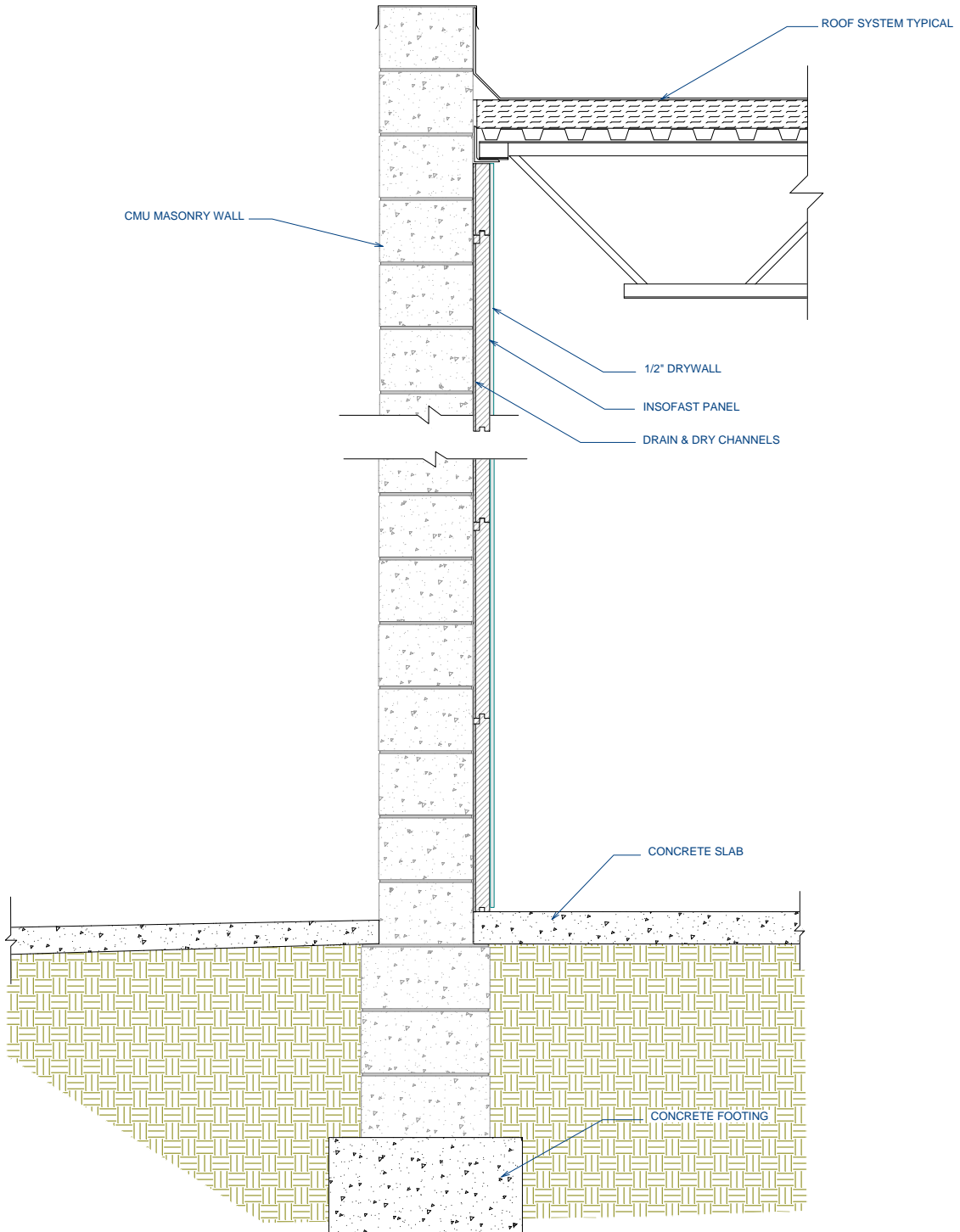

DUE TO VARIANCES IN LOCAL CODES, CONSTRUCTION PRACTICES, AND REQUIREMENTS, ALL DETAILS SHALL BE CONSTRUCTED IN ACCORDANCE WITH SUCH LOCAL CODES, CONSTRUCTION PRACTICES, AND REQUIREMENTS REGARDLESS OF DETAIL CONSTRUCTION SHOWN IN THIS DRAWING, INSOFAST, LLC MAKES NO WARRANTY, EXPRESSED OR IMPLIED. INSOFAST, LLC ASSUMES NO LEGAL LIABILITY OR RESPONSIBILITY FOR THE ACCURACY, COMPLETENESS, OR USEFULNESS OR ANY INFORMATION APPARATUS, PRODUCT OR PROCESS DISCLOSED.



CMU Masonry - Above Grade - Interior - Steel Bar Roof

888-501-7899

InSoFast, LLC

www.InSoFast.com

Scale: NOT TO SCALE

Date: March 2010

Detail #: **ISF 02.02.11**

ISF 02.02.12 CMU MASONRY - ABOVE GRADE - INTERIOR - HIGH R SYSTEM

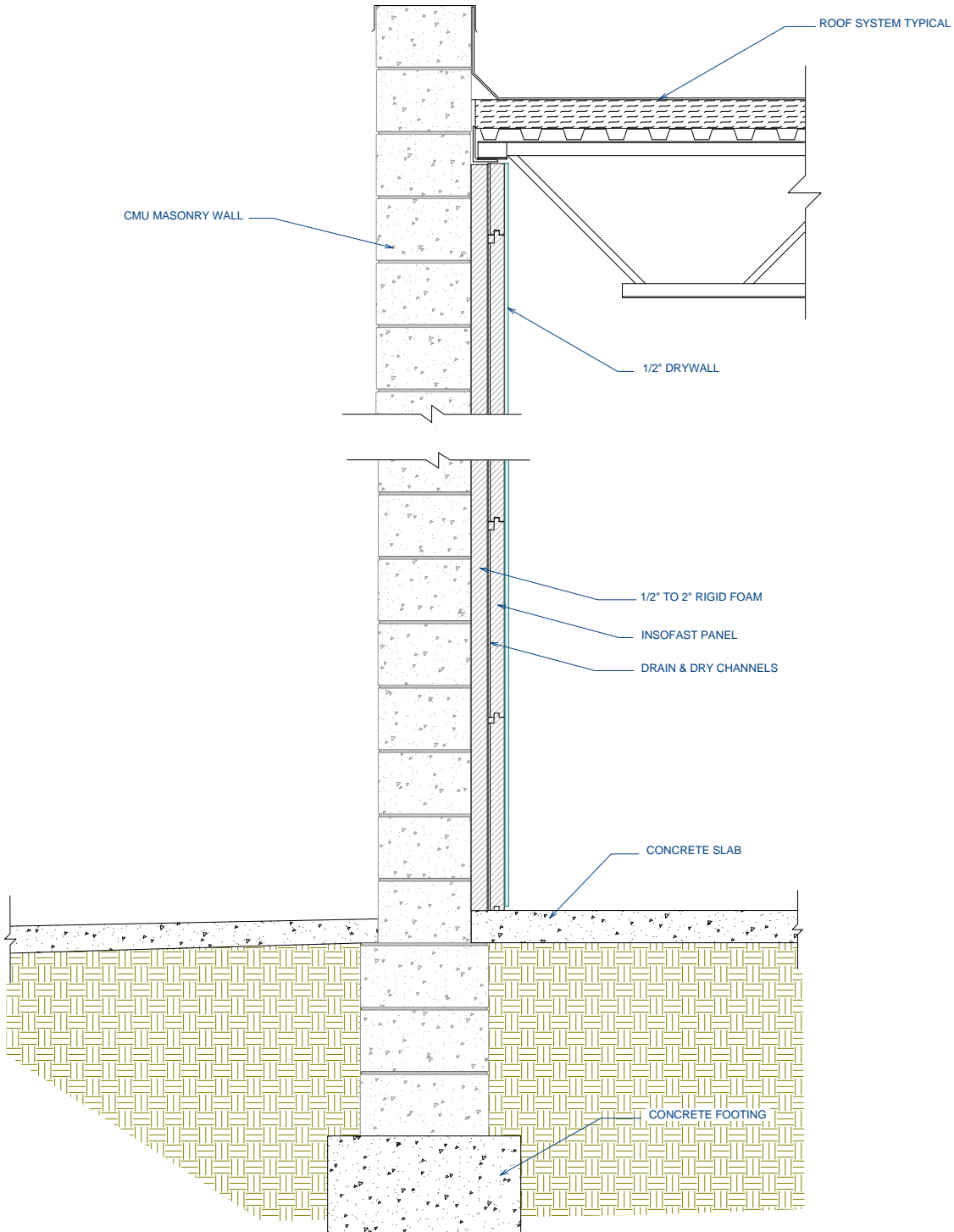

DUE TO VARIANCES IN LOCAL CODES, CONSTRUCTION PRACTICES, AND REQUIREMENTS, ALL DETAILS SHALL BE CONSTRUCTED IN ACCORDANCE WITH SUCH LOCAL CODES, CONSTRUCTION PRACTICES, AND REQUIREMENTS REGARDLESS OF DETAIL CONSTRUCTION SHOWN IN THIS DRAWING, INSOFASST, LLC MAKES NO WARRANTY, EXPRESSED OR IMPLIED. INSOFASST, LLC ASSUMES NO LEGAL LIABILITY OR RESPONSIBILITY FOR THE ACCURACY, COMPLETENESS, OR USEFULNESS OR ANY INFORMATION APPARATUS, PRODUCT OR PROCESS DISCLOSED.



CMU Masonry - Above Grade - Interior - High R System

888-501-7899

InSoFast, LLC

www.InSoFast.com

Scale: NOT TO SCALE

Date: March 2010

Detail #: **ISF 02.02.12**

ISF 02.02.12 CMU MASONRY - ABOVE GRADE - INTERIOR - DOUBLE INSOFAST

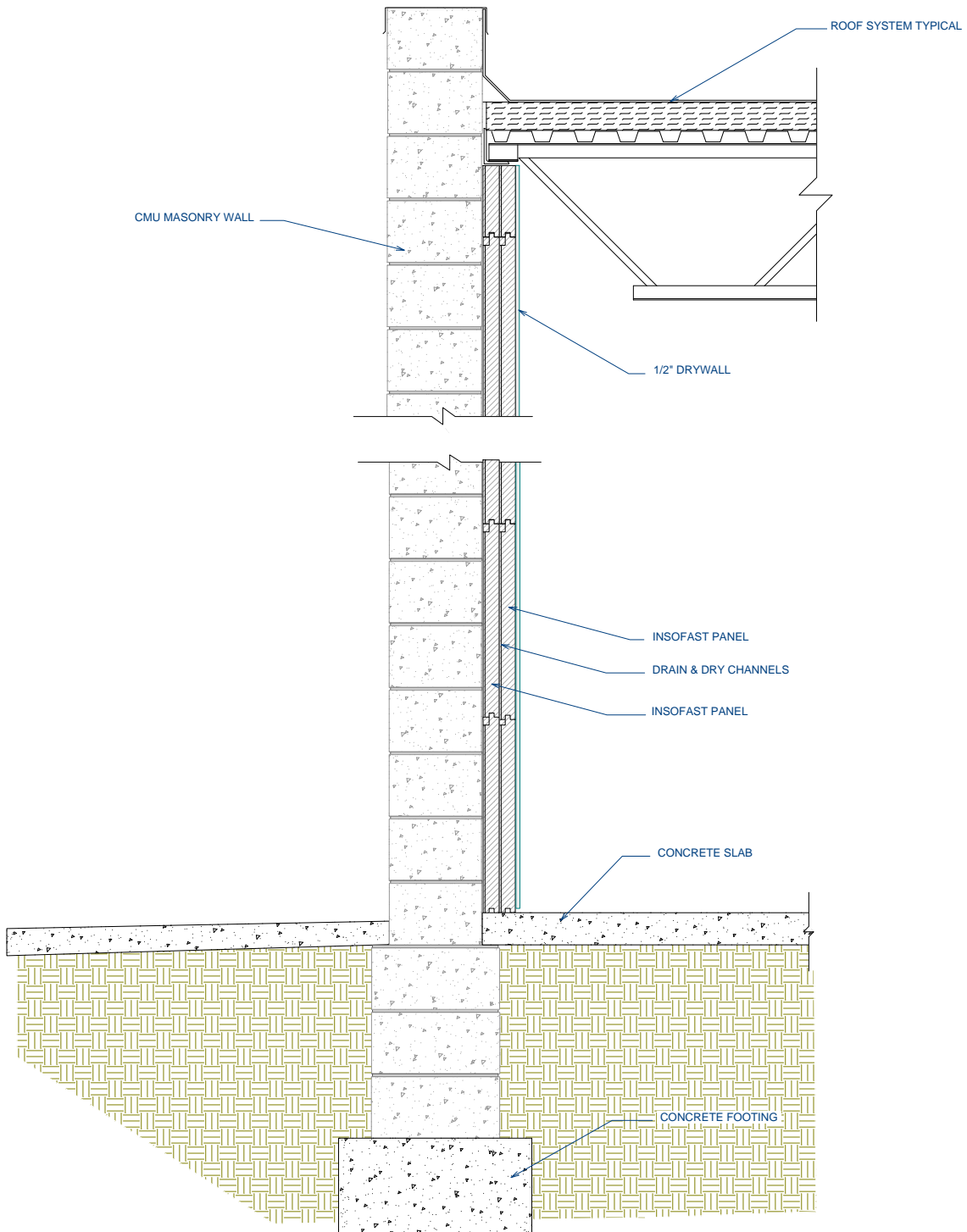

DUE TO VARIANCES IN LOCAL CODES, CONSTRUCTION PRACTICES, AND REQUIREMENTS, ALL DETAILS SHALL BE CONSTRUCTED IN ACCORDANCE WITH SUCH LOCAL CODES, CONSTRUCTION PRACTICES, AND REQUIREMENTS REGARDLESS OF DETAIL CONSTRUCTION SHOWN IN THIS DRAWING, INSOFAST, LLC MAKES NO WARRANTY, EXPRESSED OR IMPLIED. INSOFAST, LLC ASSUMES NO LEGAL LIABILITY OR RESPONSIBILITY FOR THE ACCURACY, COMPLETENESS, OR USEFULNESS OR ANY INFORMATION APPARATUS, PRODUCT OR PROCESS DISCLOSED.



CMU Masonry - Above Grade - Interior - Double InSoFast

888-501-7899

InSoFast, LLC

www.InSoFast.com

Scale: NOT TO SCALE

Date: March 2010

Detail #: **ISF 02.02.13**

ISF 02.02.21 INSOFAST - CMU MASONRY - ABOVE GRADE & BASEMENT - INTERIOR & EXTERIOR - TO START OF GRADE

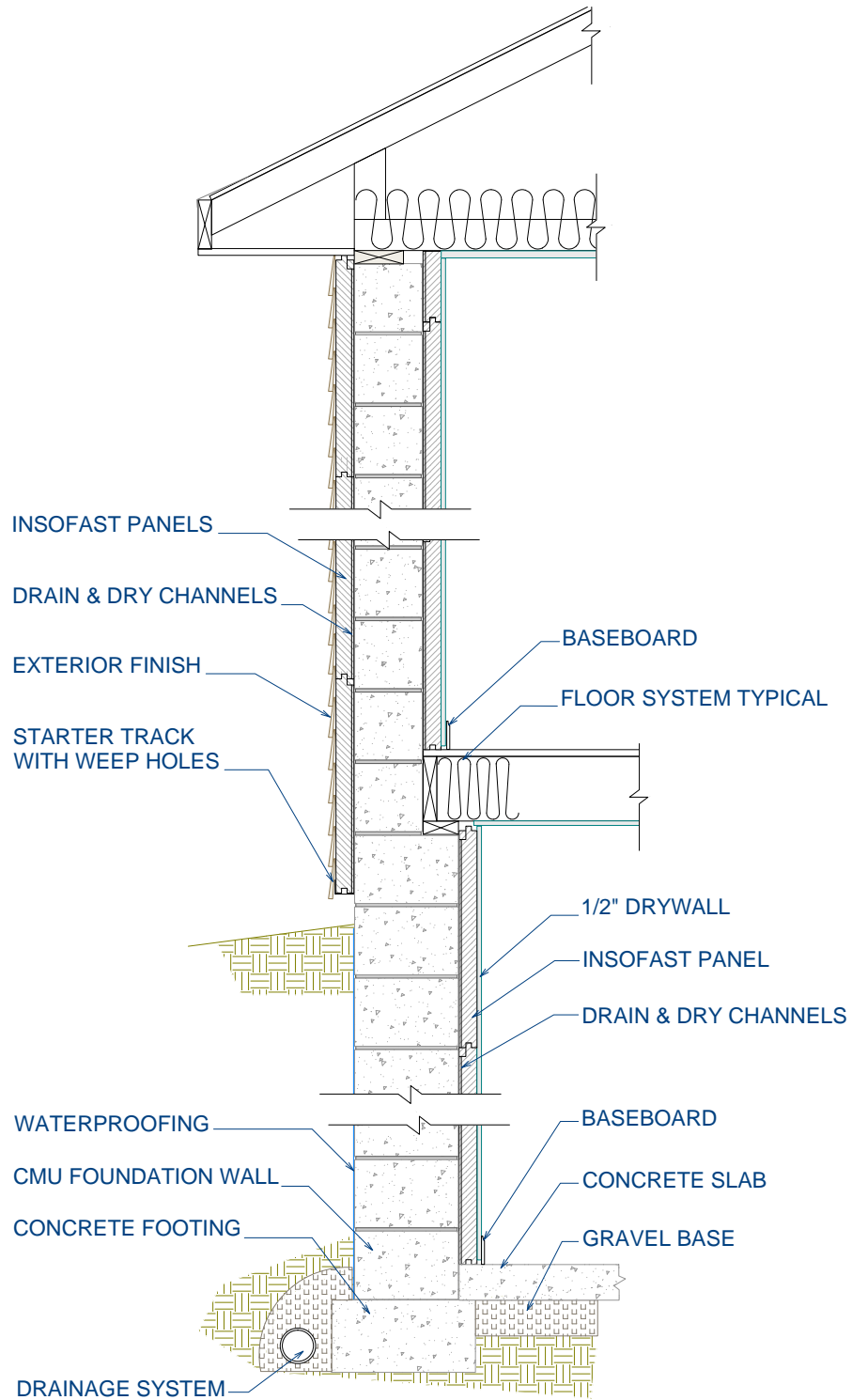

DUE TO VARIANCES IN LOCAL CODES, CONSTRUCTION PRACTICES, AND REQUIREMENTS, ALL DETAILS SHALL BE CONSTRUCTED IN ACCORDANCE WITH SUCH LOCAL CODES, CONSTRUCTION PRACTICES, AND REQUIREMENTS REGARDLESS OF DETAIL CONSTRUCTION SHOWN IN THIS DRAWING, INSOFAST, LLC MAKES NO WARRANTY, EXPRESSED OR IMPLIED. INSOFAST, LLC ASSUMES NO LEGAL LIABILITY OR RESPONSIBILITY FOR THE ACCURACY, COMPLETENESS, OR USEFULNESS OR ANY INFORMATION APPARATUS, PRODUCT OR PROCESS DISCLOSED.



CMU Masonry - Above & Below Grade - Interior & Exterior - To Start of Grade

888-501-7899

InSoFast, LLC

www.InSoFast.com

Scale: NOT TO SCALE

Date: March 2010

Detail #: **ISF 02.02.21**

ISF 02.02.22 INSOFAST - CMU MASONRY - ABOVE GRADE & BASEMENT - INTERIOR & EXTERIOR - NEW CONSTRUCTION

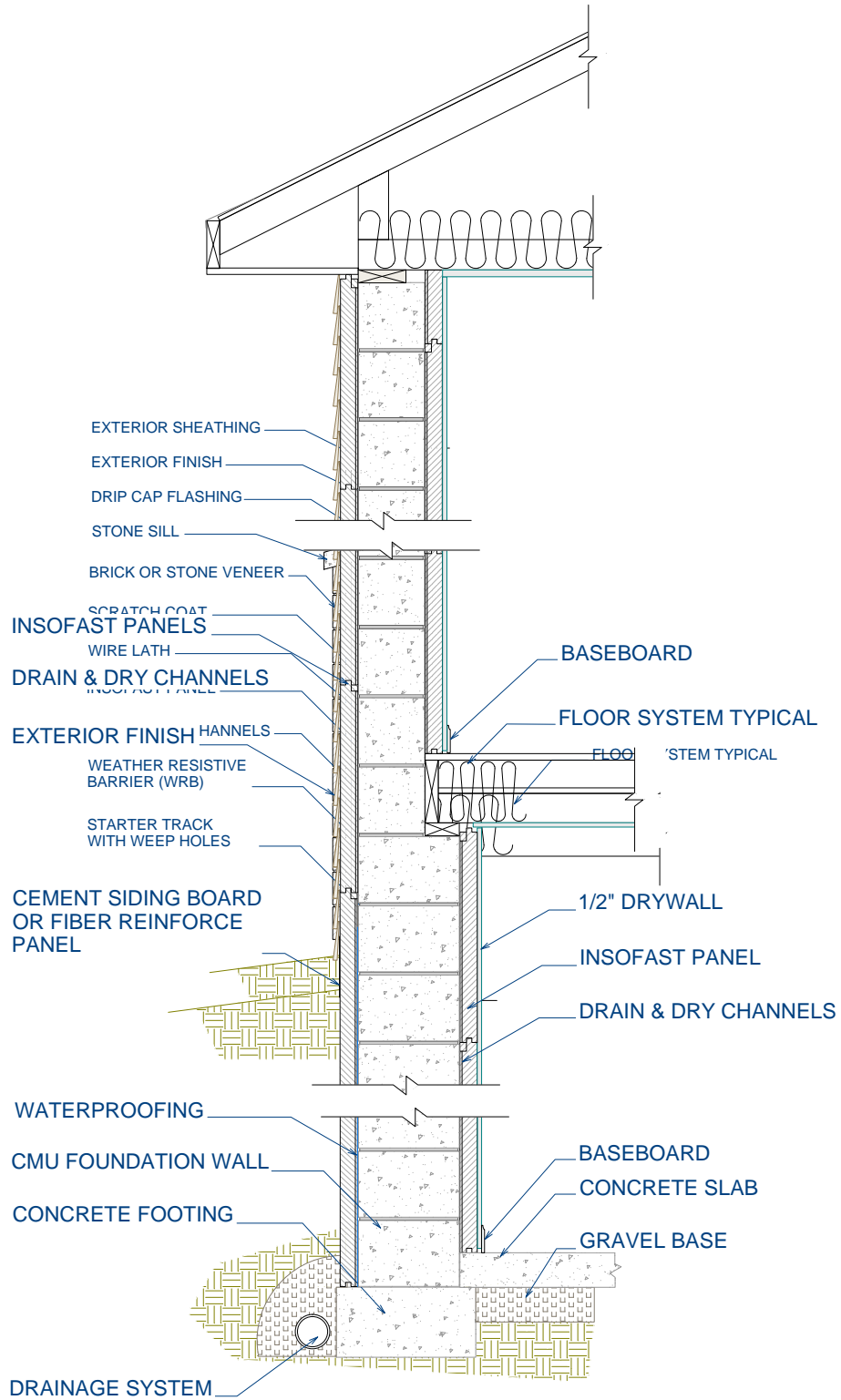

DUE TO VARIANCES IN LOCAL CODES, CONSTRUCTION PRACTICES, AND REQUIREMENTS, ALL DETAILS SHALL BE CONSTRUCTED IN ACCORDANCE WITH SUCH LOCAL CODES, CONSTRUCTION PRACTICES, AND REQUIREMENTS REGARDLESS OF DETAIL CONSTRUCTION SHOWN IN THIS DRAWING, INSOFAST, LLC MAKES NO WARRANTY, EXPRESSED OR IMPLIED. INSOFAST, LLC ASSUMES NO LEGAL LIABILITY OR RESPONSIBILITY FOR THE ACCURACY, COMPLETENESS, OR USEFULNESS OR ANY INFORMATION APPARATUS, PRODUCT OR PROCESS DISCLOSED.



CMU Masonry - Above & Below Grade - Interior & Exterior - New Construction

888-501-7899

InSoFast, LLC

www.InSoFast.com

Scale: NOT TO SCALE

Date: March 2010

Detail #: **ISF 02.02.22**

ISF 03.02.01 INSOFAST - CONCRETE WALL - INTERIOR - STEEL BAR ROOF

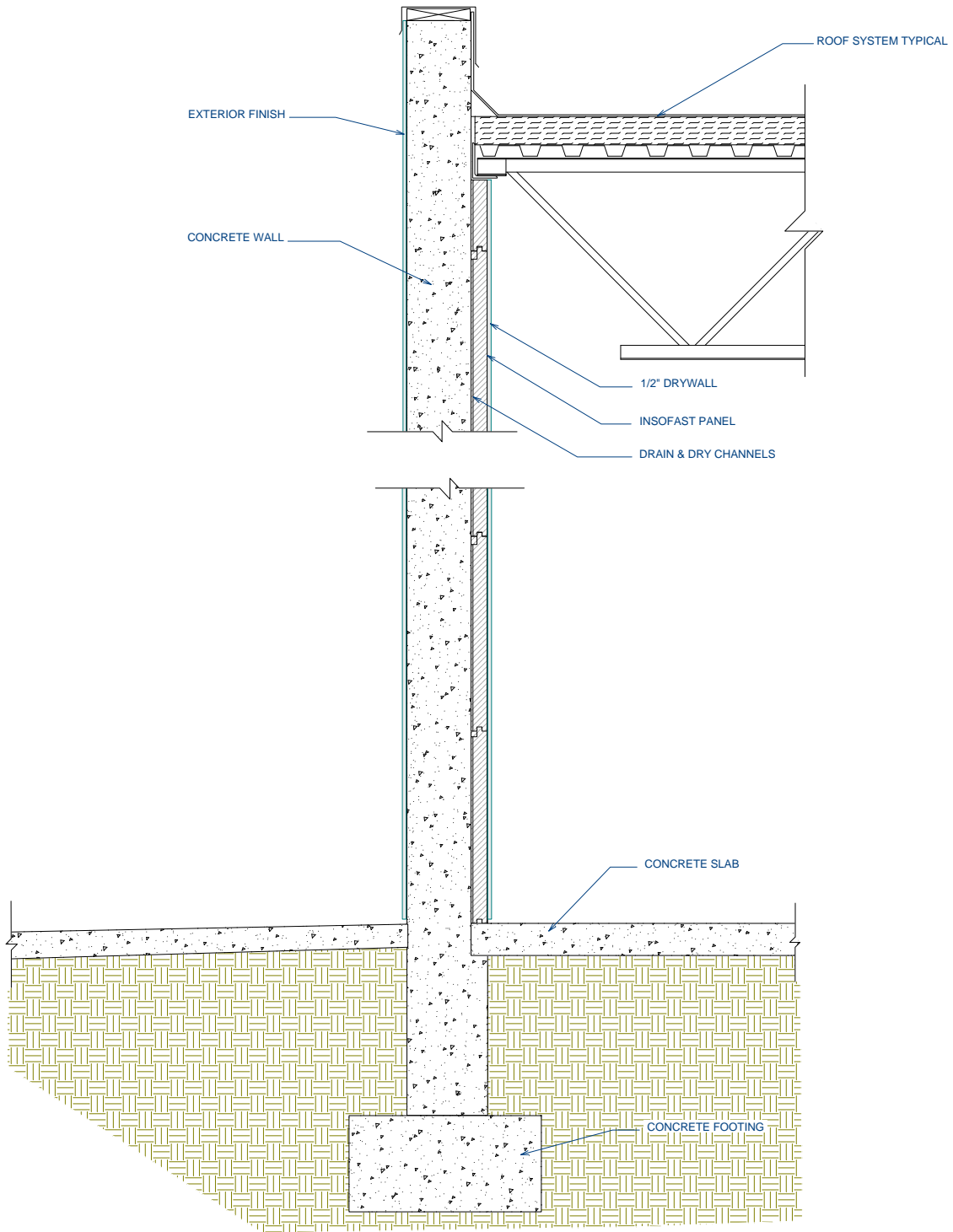

DUE TO VARIANCES IN LOCAL CODES, CONSTRUCTION PRACTICES, AND REQUIREMENTS, ALL DETAILS SHALL BE CONSTRUCTED IN ACCORDANCE WITH SUCH LOCAL CODES, CONSTRUCTION PRACTICES, AND REQUIREMENTS REGARDLESS OF DETAIL CONSTRUCTION SHOWN IN THIS DRAWING. INSOFAST, LLC MAKES NO WARRANTY, EXPRESSED OR IMPLIED. INSOFAST, LLC ASSUMES NO LEGAL LIABILITY OR RESPONSIBILITY FOR THE ACCURACY, COMPLETENESS, OR USEFULNESS OR ANY INFORMATION APPARATUS, PRODUCT OR PROCESS DISCLOSED.



Concrete Wall - Interior - Steel Bar Roof

888-501-7899

InSoFast, LLC

www.InSoFast.com

Scale: NOT TO SCALE

Date: March 2010

Detail #: **ISF 03.02.01**

ISF 03.02.05 INSOFAST - CONCRETE WALL - INTERIOR - HIGH R SYSTEM

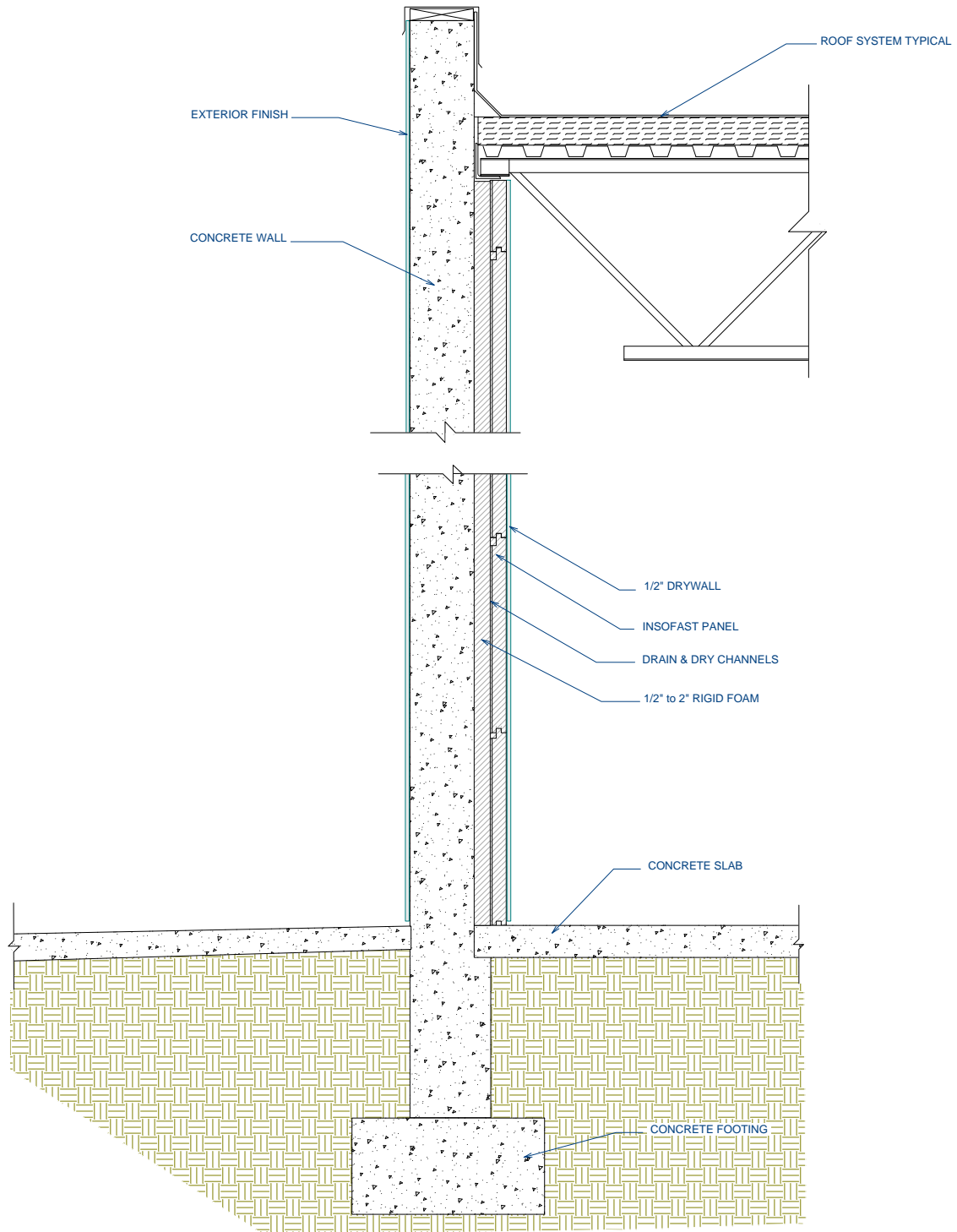

DUE TO VARIANCES IN LOCAL CODES, CONSTRUCTION PRACTICES, AND REQUIREMENTS, ALL DETAILS SHALL BE CONSTRUCTED IN ACCORDANCE WITH SUCH LOCAL CODES, CONSTRUCTION PRACTICES, AND REQUIREMENTS REGARDLESS OF DETAIL CONSTRUCTION SHOWN IN THIS DRAWING, INSOFAST, LLC MAKES NO WARRANTY, EXPRESSED OR IMPLIED. INSOFAST, LLC ASSUMES NO LEGAL LIABILITY OR RESPONSIBILITY FOR THE ACCURACY, COMPLETENESS, OR USEFULNESS OR ANY INFORMATION APPARATUS, PRODUCT OR PROCESS DISCLOSED.



Concrete Wall - Interior - High R System

888-501-7899

InSoFast, LLC

www.InSoFast.com

Scale: NOT TO SCALE

Date: March 2010

Detail #: **ISF 03.02.05**

ISF 03.02.21 INSOFast - CONCRETE WALL - INTERIOR & EXTERIOR - STEEL BAR ROOF

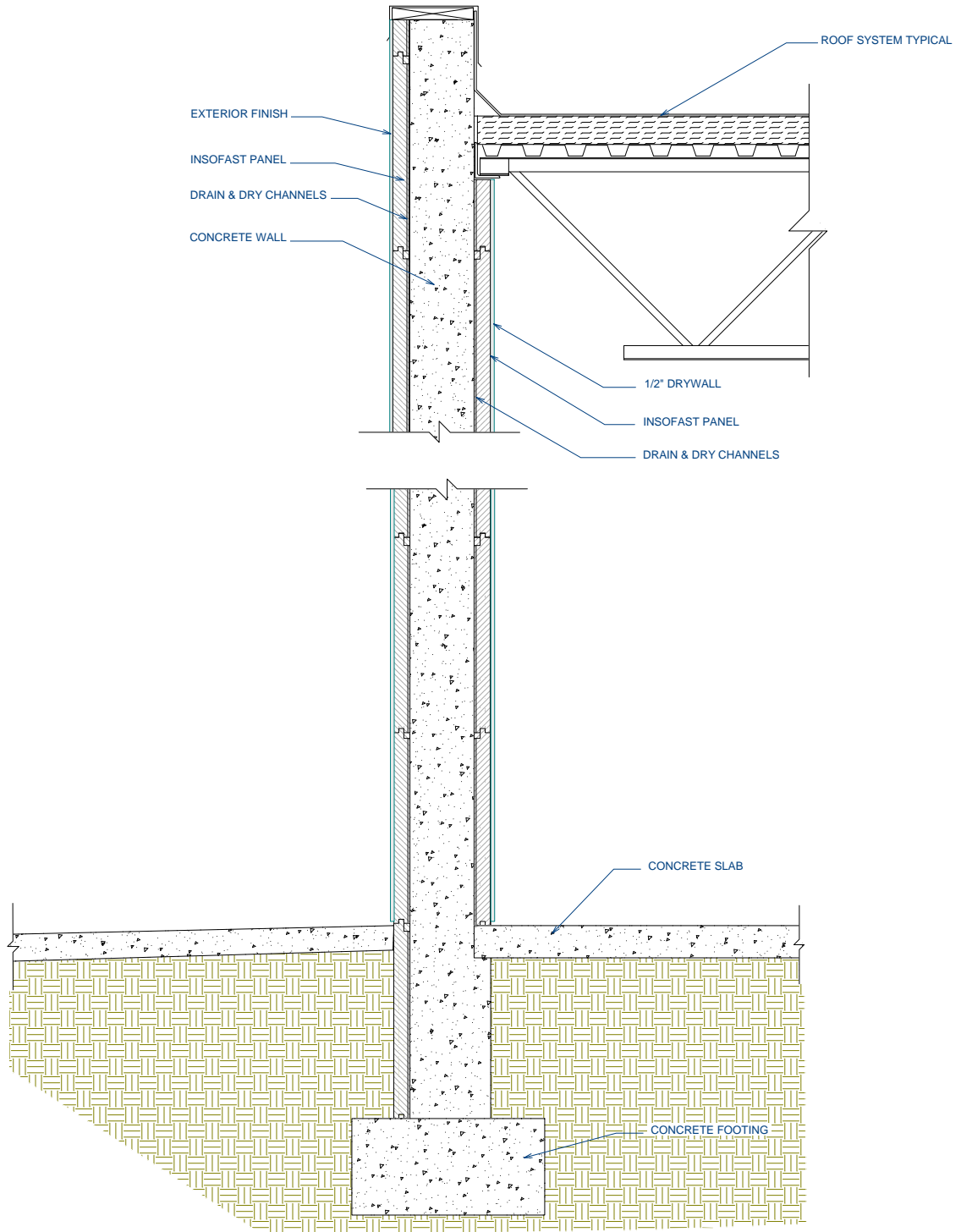

DUE TO VARIANCES IN LOCAL CODES, CONSTRUCTION PRACTICES, AND REQUIREMENTS, ALL DETAILS SHALL BE CONSTRUCTED IN ACCORDANCE WITH SUCH LOCAL CODES, CONSTRUCTION PRACTICES, AND REQUIREMENTS REGARDLESS OF DETAIL CONSTRUCTION SHOWN IN THIS DRAWING. INSOFast, LLC MAKES NO WARRANTY, EXPRESSED OR IMPLIED. INSOFast, LLC ASSUMES NO LEGAL LIABILITY OR RESPONSIBILITY FOR THE ACCURACY, COMPLETENESS, OR USEFULNESS OR ANY INFORMATION APPARATUS, PRODUCT OR PROCESS DISCLOSED.



Concrete Wall - Interior & Exterior - Steel Bar Roof

888-501-7899

InSoFast, LLC

www.InSoFast.com

Scale: NOT TO SCALE

Date: March 2010

Detail #: **ISF 03.02.21**

ISF 04.01.01 INSOFAST - STEEL FRAMED - OVER EXISTING INTERIOR

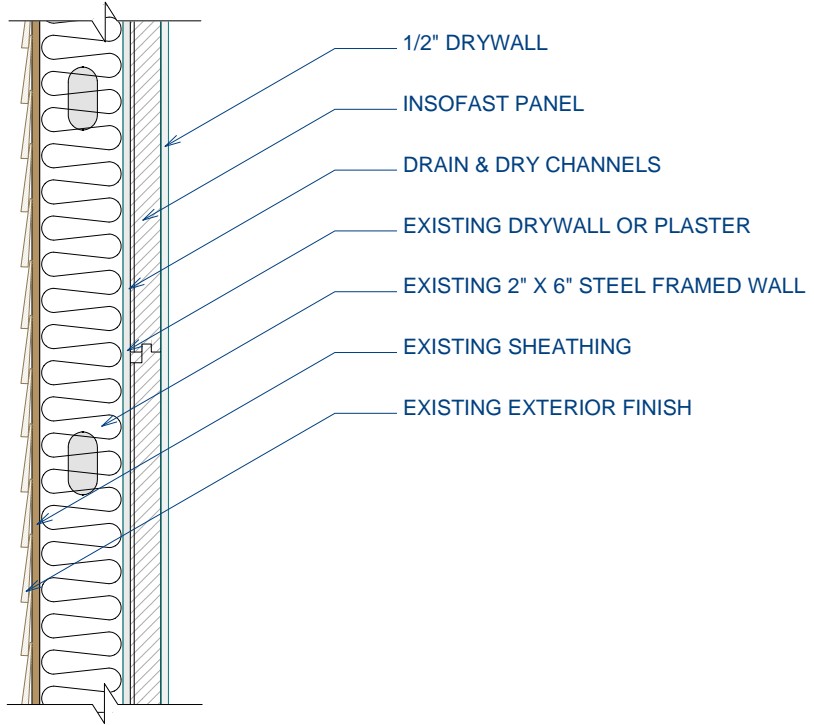

DUE TO VARIANCES IN LOCAL CODES, CONSTRUCTION PRACTICES, AND REQUIREMENTS, ALL DETAILS SHALL BE CONSTRUCTED IN ACCORDANCE WITH SUCH LOCAL CODES, CONSTRUCTION PRACTICES, AND REQUIREMENTS REGARDLESS OF DETAIL CONSTRUCTION SHOWN IN THIS DRAWING, INSOFAST, LLC MAKES NO WARRANTY, EXPRESSED OR IMPLIED. INSOFAST, LLC ASSUMES NO LEGAL LIABILITY OR RESPONSIBILITY FOR THE ACCURACY, COMPLETENESS, OR USEFULNESS OR ANY INFORMATION APPARATUS, PRODUCT OR PROCESS DISCLOSED.



Steel Framed - Over Existing Interior

Scale: NOT TO SCALE

Date: March 2010

888-501-7899

InSoFast, LLC

www.InSoFast.com

Detail #: **ISF 04.01.01**

ISF 04.01.02 INSOFAST - STEEL FRAMED - OVER EXISTING INTERIOR - HIGH R SYSTEM

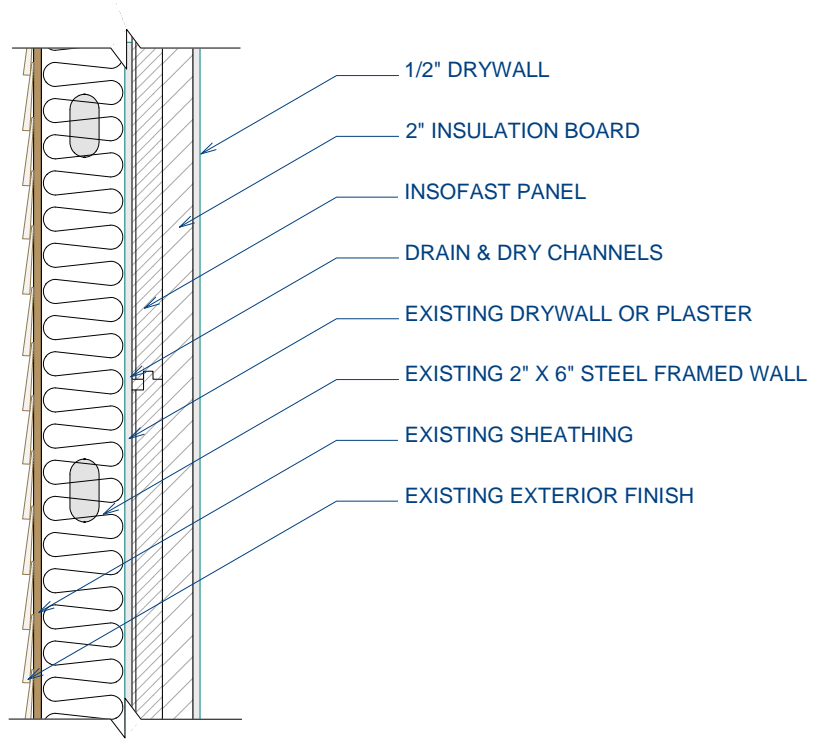

DUE TO VARIANCES IN LOCAL CODES, CONSTRUCTION PRACTICES, AND REQUIREMENTS, ALL DETAILS SHALL BE CONSTRUCTED IN ACCORDANCE WITH SUCH LOCAL CODES, CONSTRUCTION PRACTICES, AND REQUIREMENTS REGARDLESS OF DETAIL CONSTRUCTION SHOWN IN THIS DRAWING, INSOFAST, LLC MAKES NO WARRANTY, EXPRESSED OR IMPLIED. INSOFAST, LLC ASSUMES NO LEGAL LIABILITY OR RESPONSIBILITY FOR THE ACCURACY, COMPLETENESS, OR USEFULNESS OR ANY INFORMATION APPARATUS, PRODUCT OR PROCESS DISCLOSED.



Steel Framed - Over Existing Interior - High R System

888-501-7899

InSoFast, LLC

www.InSoFast.com

Scale: NOT TO SCALE

Date: March 2010

Detail #: **ISF 04.01.02**

ISF 04.02.01 INSOFAST - STEEL FRAMED - EXTERIOR

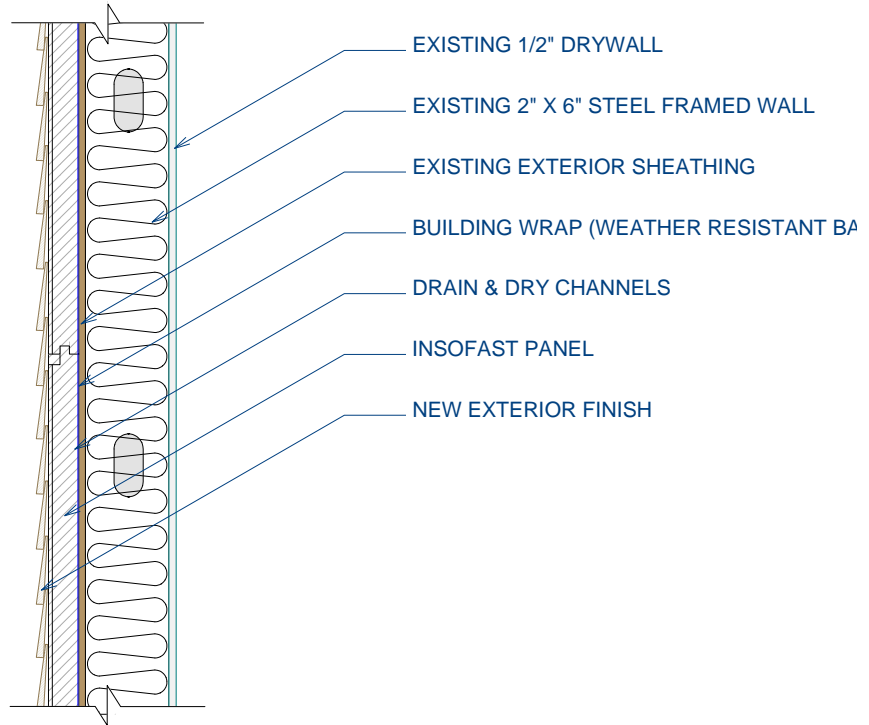

DUE TO VARIANCES IN LOCAL CODES, CONSTRUCTION PRACTICES, AND REQUIREMENTS, ALL DETAILS SHALL BE CONSTRUCTED IN ACCORDANCE WITH SUCH LOCAL CODES, CONSTRUCTION PRACTICES, AND REQUIREMENTS REGARDLESS OF DETAIL CONSTRUCTION SHOWN IN THIS DRAWING, INSOFAST, LLC MAKES NO WARRANTY, EXPRESSED OR IMPLIED. INSOFAST, LLC ASSUMES NO LEGAL LIABILITY OR RESPONSIBILITY FOR THE ACCURACY, COMPLETENESS, OR USEFULNESS OR ANY INFORMATION APPARATUS, PRODUCT OR PROCESS DISCLOSED.



Wood Framed - Exterior

Scale: NOT TO SCALE

Date: March 2010

888-501-7899

InSoFast, LLC

www.InSoFast.com

Detail #: **ISF 04.02.01**

ISF 04.02.02 INSOFAST - STEEL FRAMED - OVER EXISTING SIDING

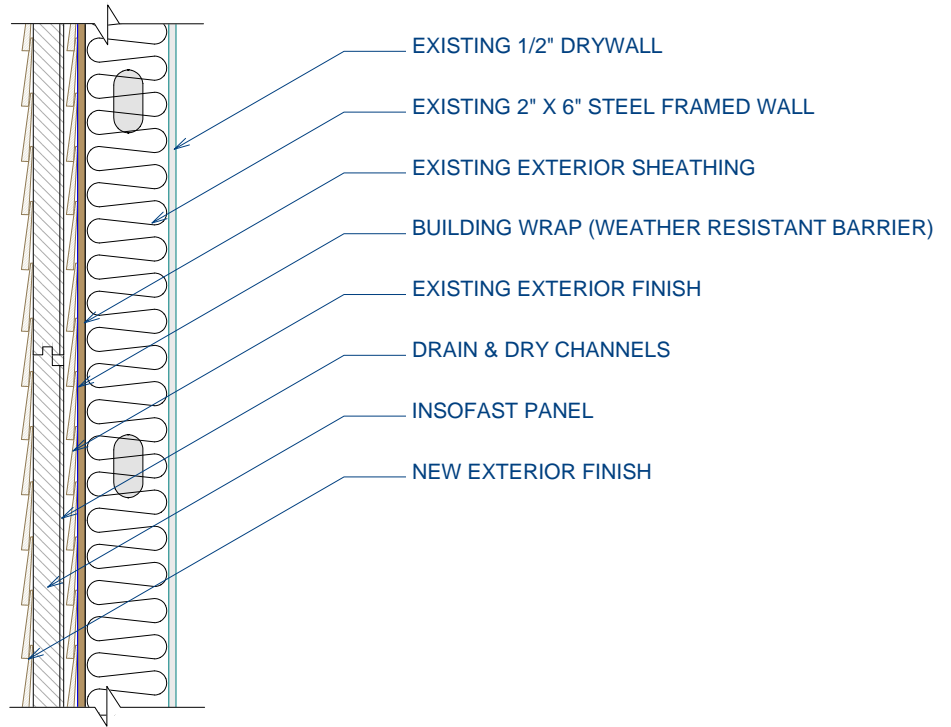

DUE TO VARIANCES IN LOCAL CODES, CONSTRUCTION PRACTICES, AND REQUIREMENTS, ALL DETAILS SHALL BE CONSTRUCTED IN ACCORDANCE WITH SUCH LOCAL CODES, CONSTRUCTION PRACTICES, AND REQUIREMENTS REGARDLESS OF DETAIL CONSTRUCTION SHOWN IN THIS DRAWING, INSOFAST, LLC MAKES NO WARRANTY, EXPRESSED OR IMPLIED. INSOFAST, LLC ASSUMES NO LEGAL LIABILITY OR RESPONSIBILITY FOR THE ACCURACY, COMPLETENESS, OR USEFULNESS OR ANY INFORMATION APPARATUS, PRODUCT OR PROCESS DISCLOSED.



Steel Framed - Over Existing Siding

Scale: NOT TO SCALE

Date: March 2010

888-501-7899

InSoFast, LLC

www.InSoFast.com

Detail #: **ISF 04.02.02**

ISF 05.01.01 WOOD FRAMED - OVER EXISTING INTERIOR

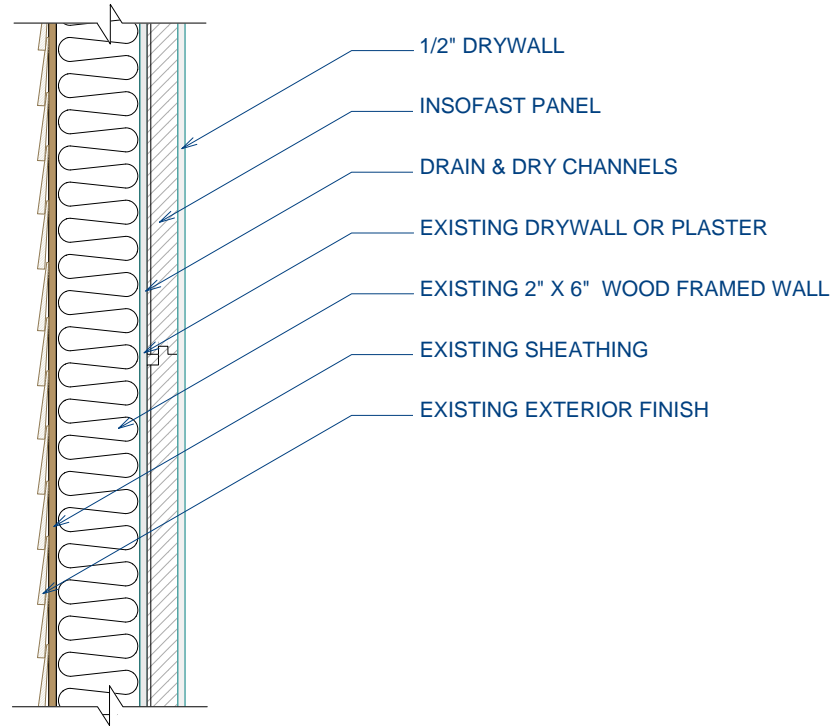

DUE TO VARIANCES IN LOCAL CODES, CONSTRUCTION PRACTICES, AND REQUIREMENTS, ALL DETAILS SHALL BE CONSTRUCTED IN ACCORDANCE WITH SUCH LOCAL CODES, CONSTRUCTION PRACTICES, AND REQUIREMENTS REGARDLESS OF DETAIL CONSTRUCTION SHOWN IN THIS DRAWING, INSOFAST, LLC MAKES NO WARRANTY, EXPRESSED OR IMPLIED. INSOFAST, LLC ASSUMES NO LEGAL LIABILITY OR RESPONSIBILITY FOR THE ACCURACY, COMPLETENESS, OR USEFULNESS OR ANY INFORMATION APPARATUS, PRODUCT OR PROCESS DISCLOSED.



Wood Framed - Over Existing Interior

888-501-7899

InSoFast, LLC

www.InSoFast.com

Scale: NOT TO SCALE

Date: March 2010

Detail #: **ISF 05.01.01**

ISF 05.01.02 INSOFAST - WOOD FRAMED - OVER EXISTING INTERIOR - HIGH R SYSTEM

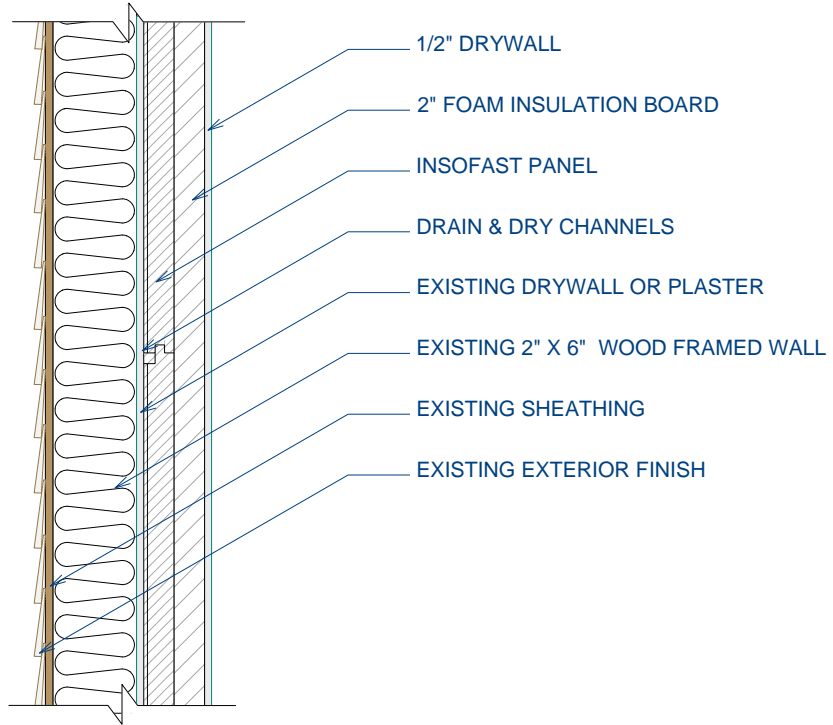

DUE TO VARIANCES IN LOCAL CODES, CONSTRUCTION PRACTICES, AND REQUIREMENTS, ALL DETAILS SHALL BE CONSTRUCTED IN ACCORDANCE WITH SUCH LOCAL CODES, CONSTRUCTION PRACTICES, AND REQUIREMENTS REGARDLESS OF DETAIL CONSTRUCTION SHOWN IN THIS DRAWING, INSOFAST, LLC MAKES NO WARRANTY, EXPRESSED OR IMPLIED. INSOFAST, LLC ASSUMES NO LEGAL LIABILITY OR RESPONSIBILITY FOR THE ACCURACY, COMPLETENESS, OR USEFULNESS OR ANY INFORMATION APPARATUS, PRODUCT OR PROCESS DISCLOSED.



Wood Framed - Over Existing Interior - High R System

888-501-7899

InSoFast, LLC

www.InSoFast.com

Scale: NOT TO SCALE

Date: March 2010

Detail #: **ISF 05.01.02**

ISF 05.02.01 INSOFAST - WOOD FRAMED - EXTERIOR

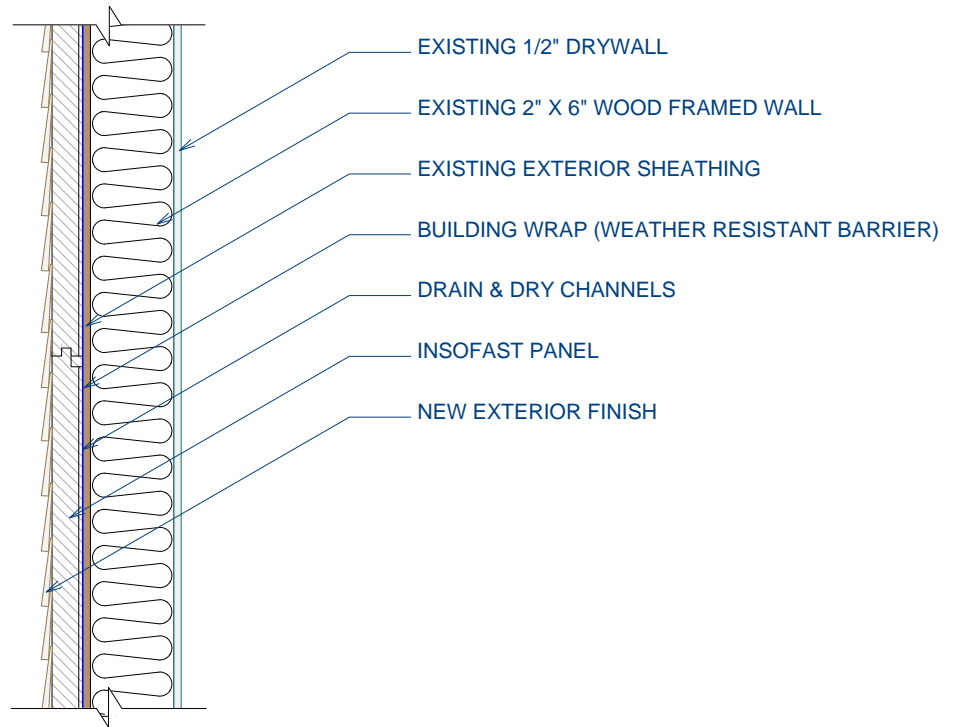

DUE TO VARIANCES IN LOCAL CODES, CONSTRUCTION PRACTICES, AND REQUIREMENTS, ALL DETAILS SHALL BE CONSTRUCTED IN ACCORDANCE WITH SUCH LOCAL CODES, CONSTRUCTION PRACTICES, AND REQUIREMENTS REGARDLESS OF DETAIL CONSTRUCTION SHOWN IN THIS DRAWING, INSOFAST, LLC MAKES NO WARRANTY, EXPRESSED OR IMPLIED. INSOFAST, LLC ASSUMES NO LEGAL LIABILITY OR RESPONSIBILITY FOR THE ACCURACY, COMPLETENESS, OR USEFULNESS OR ANY INFORMATION APPARATUS, PRODUCT OR PROCESS DISCLOSED.



Wood Framed - Exterior

Scale: NOT TO SCALE

Date: March 2010

888-501-7899

InSoFast, LLC

www.InSoFast.com

Detail #: **ISF 05.02.01**

ISF 05.02.02 INSOFAST - WOOD FRAMED - OVER EXISTING SIDING

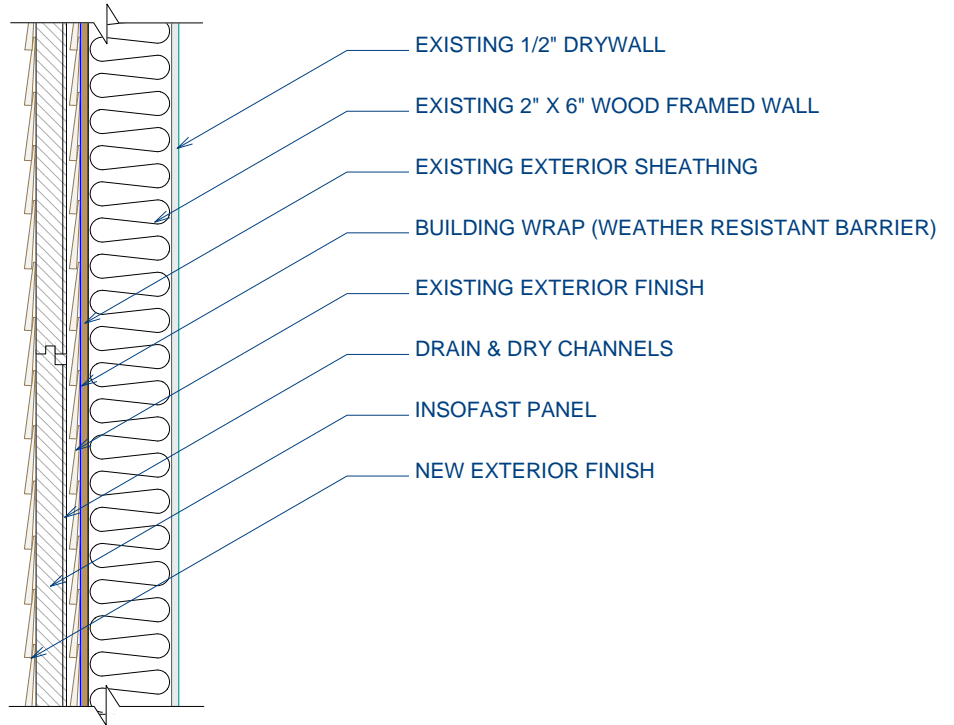

DUE TO VARIANCES IN LOCAL CODES, CONSTRUCTION PRACTICES, AND REQUIREMENTS, ALL DETAILS SHALL BE CONSTRUCTED IN ACCORDANCE WITH SUCH LOCAL CODES, CONSTRUCTION PRACTICES, AND REQUIREMENTS REGARDLESS OF DETAIL CONSTRUCTION SHOWN IN THIS DRAWING, INSOFAST, LLC MAKES NO WARRANTY, EXPRESSED OR IMPLIED. INSOFAST, LLC ASSUMES NO LEGAL LIABILITY OR RESPONSIBILITY FOR THE ACCURACY, COMPLETENESS, OR USEFULNESS OR ANY INFORMATION APPARATUS, PRODUCT OR PROCESS DISCLOSED.



Wood Framed - Over Existing Siding

888-501-7899

InSoFast, LLC

www.InSoFast.com

Scale: NOT TO SCALE

Date: March 2010

Detail #: **ISF 05.02.02**

ISF 05.02.03 INSOFAST - WOOD FRAMED - ABOVE GRADE - EXTERIOR - MANUFACTURED STONE

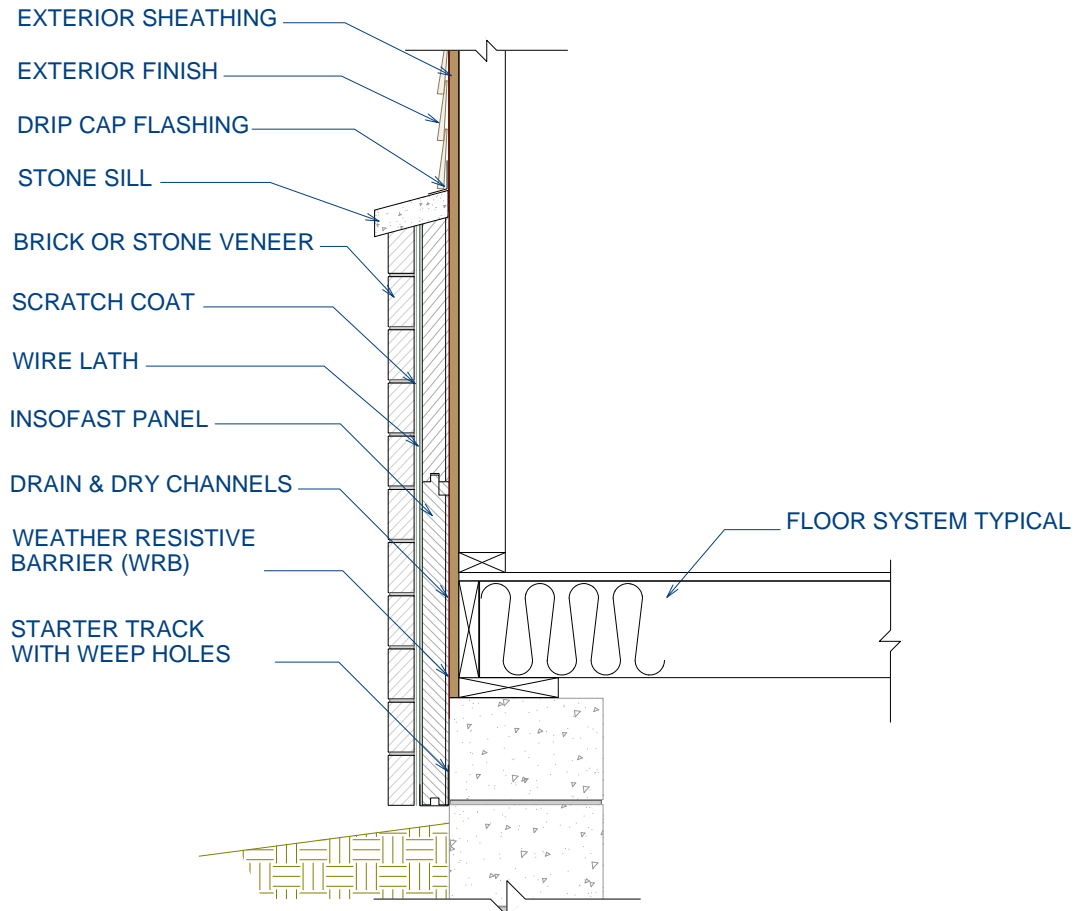

DUE TO VARIANCES IN LOCAL CODES, CONSTRUCTION PRACTICES, AND REQUIREMENTS, ALL DETAILS SHALL BE CONSTRUCTED IN ACCORDANCE WITH SUCH LOCAL CODES, CONSTRUCTION PRACTICES, AND REQUIREMENTS REGARDLESS OF DETAIL CONSTRUCTION SHOWN IN THIS DRAWING, INSOFAST, LLC MAKES NO WARRANTY, EXPRESSED OR IMPLIED. INSOFAST, LLC ASSUMES NO LEGAL LIABILITY OR RESPONSIBILITY FOR THE ACCURACY, COMPLETENESS, OR USEFULNESS OR ANY INFORMATION APPARATUS, PRODUCT OR PROCESS DISCLOSED.



Wood Framed - Above Grade - Exterior - Manufactured Stone

888-501-7899

InSoFast, LLC

www.InSoFast.com

Scale: NOT TO SCALE

Date: March 2010

Detail #: **ISF 05.02.03**

ISF 06.02.01 INSOFast - HOLLOW CORE PLANK - CEILING APPLICATION

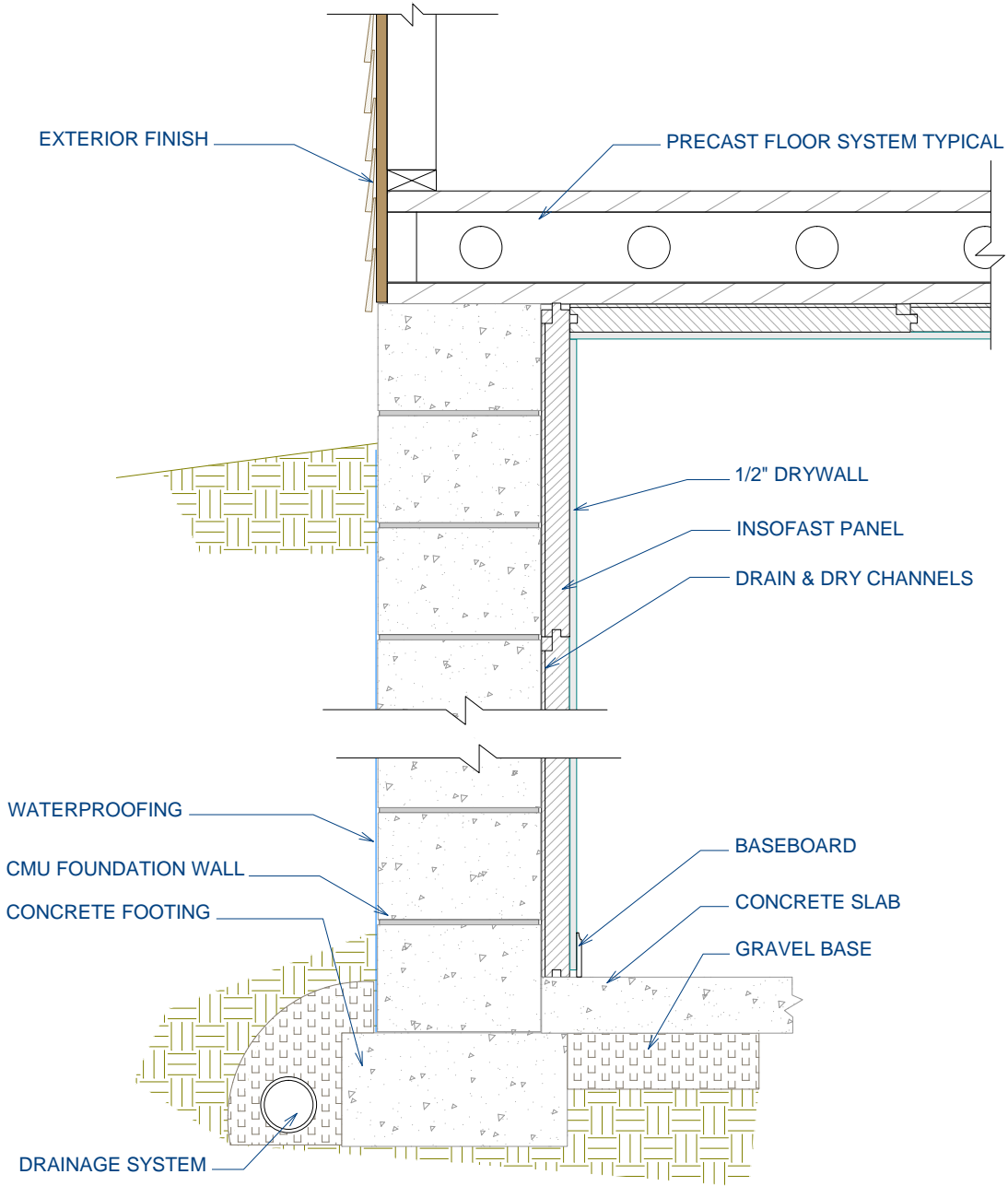

DUE TO VARIANCES IN LOCAL CODES, CONSTRUCTION PRACTICES, AND REQUIREMENTS, ALL DETAILS SHALL BE CONSTRUCTED IN ACCORDANCE WITH SUCH LOCAL CODES, CONSTRUCTION PRACTICES, AND REQUIREMENTS REGARDLESS OF DETAIL CONSTRUCTION SHOWN IN THIS DRAWING, INSOFast, LLC MAKES NO WARRANTY, EXPRESSED OR IMPLIED. INSOFast, LLC ASSUMES NO LEGAL LIABILITY OR RESPONSIBILITY FOR THE ACCURACY, COMPLETENESS, OR USEFULNESS OR ANY INFORMATION APPARATUS, PRODUCT OR PROCESS DISCLOSED.



Hollow Core Plank - Ceiling Application

Scale: NOT TO SCALE

Date: March 2010

888-501-7899

InSoFast, LLC

www.InSoFast.com

Detail #: **ISF 06.02.01**

ISF 07.01.01 INSOFAST - WINDOW - CMU - INSET WINDOW - RETROFIT

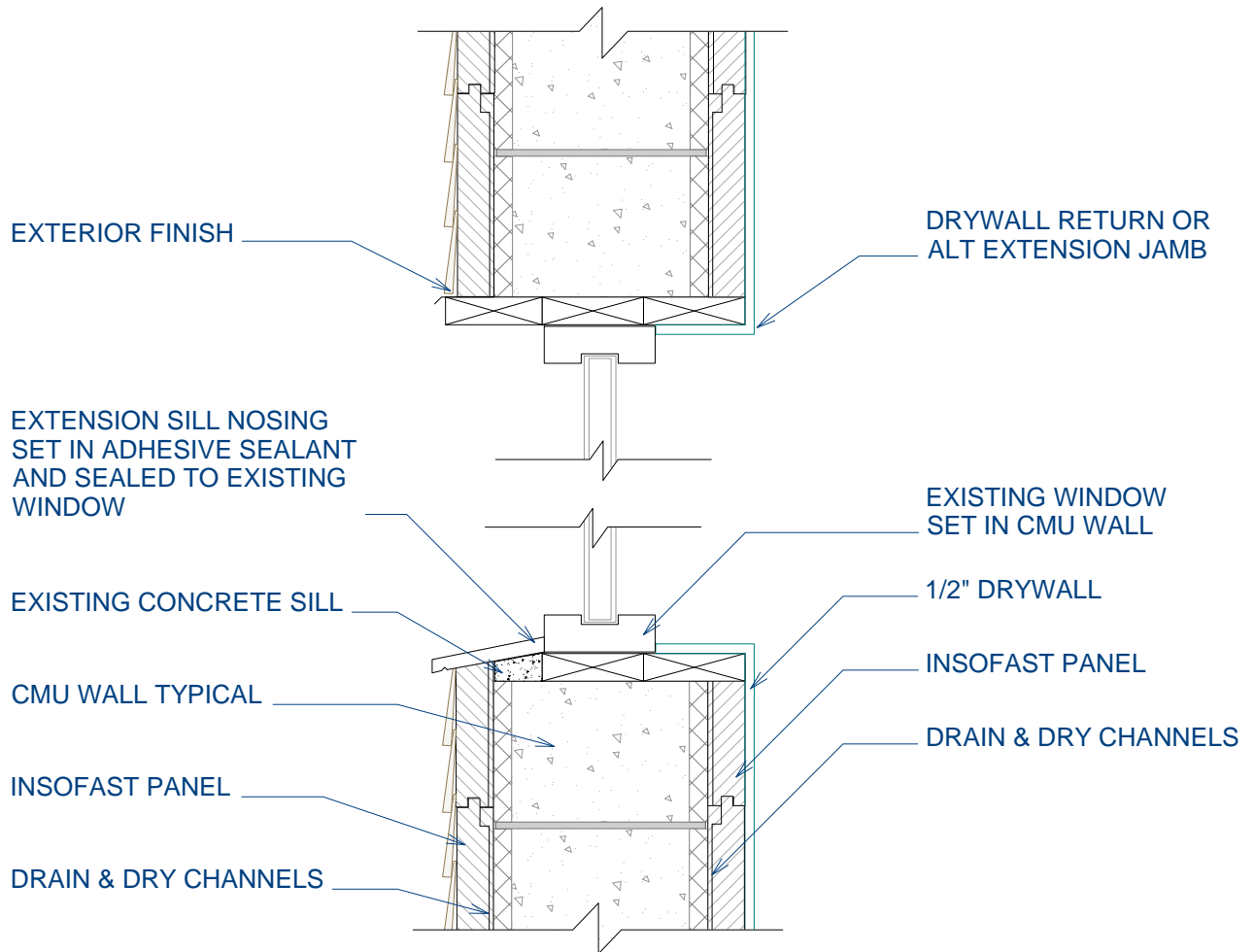

DUE TO VARIANCES IN LOCAL CODES, CONSTRUCTION PRACTICES, AND REQUIREMENTS, ALL DETAILS SHALL BE CONSTRUCTED IN ACCORDANCE WITH SUCH LOCAL CODES, CONSTRUCTION PRACTICES, AND REQUIREMENTS REGARDLESS OF DETAIL CONSTRUCTION SHOWN IN THIS DRAWING, INSOFAST, LLC MAKES NO WARRANTY, EXPRESSED OR IMPLIED. INSOFAST, LLC ASSUMES NO LEGAL LIABILITY OR RESPONSIBILITY FOR THE ACCURACY, COMPLETENESS, OR USEFULNESS OR ANY INFORMATION APPARATUS, PRODUCT OR PROCESS DISCLOSED.



Window - CMU - Inset Window - Retrofit

888-501-7899

InSoFast, LLC

www.InSoFast.com

Scale: NOT TO SCALE

Date: March 2010

Detail #: **ISF 07.01.01**

ISF 07.01.02 INSOFAST - WINDOW - CMU - FLUSH WINDOW - RETROFIT

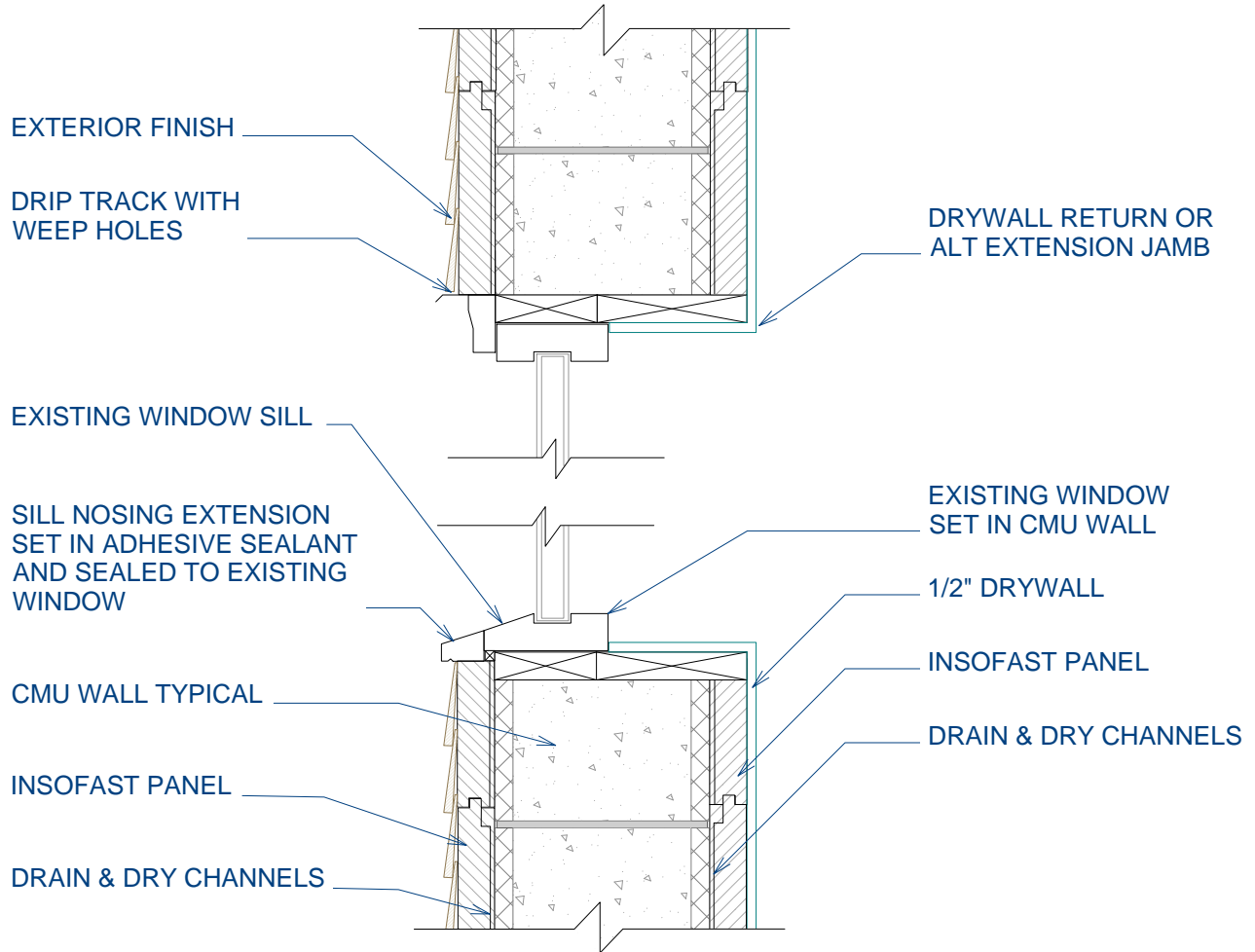

DUE TO VARIANCES IN LOCAL CODES, CONSTRUCTION PRACTICES, AND REQUIREMENTS, ALL DETAILS SHALL BE CONSTRUCTED IN ACCORDANCE WITH SUCH LOCAL CODES, CONSTRUCTION PRACTICES, AND REQUIREMENTS REGARDLESS OF DETAIL CONSTRUCTION SHOWN IN THIS DRAWING, INSOFAST, LLC MAKES NO WARRANTY, EXPRESSED OR IMPLIED. INSOFAST, LLC ASSUMES NO LEGAL LIABILITY OR RESPONSIBILITY FOR THE ACCURACY, COMPLETENESS, OR USEFULNESS OR ANY INFORMATION APPARATUS, PRODUCT OR PROCESS DISCLOSED.



Window - CMU - Flush Window - Retrofit

888-501-7899

InSoFast, LLC

www.InSoFast.com

Scale: NOT TO SCALE

Date: March 2010

Detail #: **ISF 07.01.02**

ISF 07.01.21 INSOFAST - WINDOW DETAIL - CMU - RETURN WITH FIBER REINFORCED PANEL (FRP)

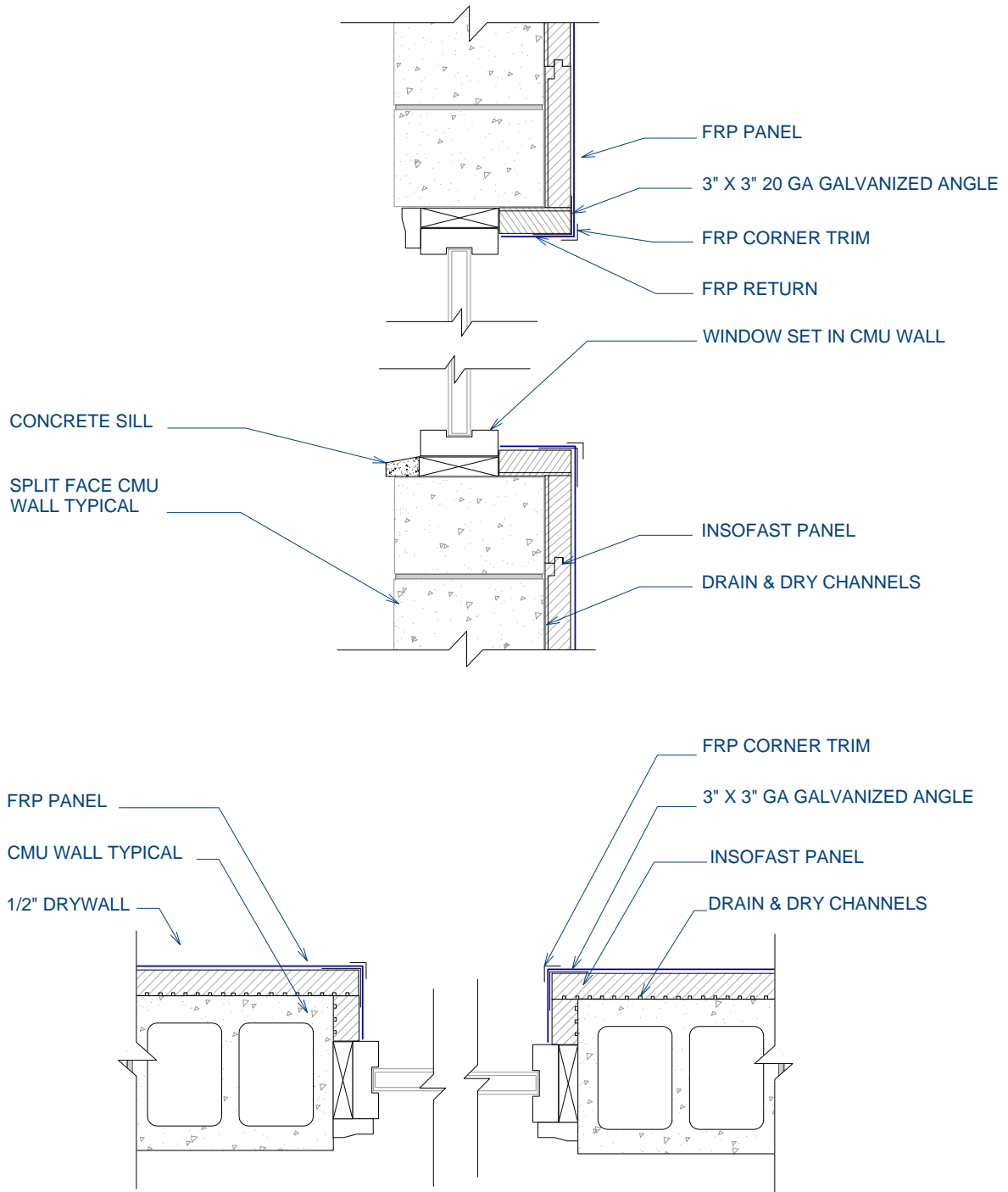

DUE TO VARIANCES IN LOCAL CODES, CONSTRUCTION PRACTICES, AND REQUIREMENTS, ALL DETAILS SHALL BE CONSTRUCTED IN ACCORDANCE WITH SUCH LOCAL CODES, CONSTRUCTION PRACTICES, AND REQUIREMENTS REGARDLESS OF DETAIL CONSTRUCTION SHOWN IN THIS DRAWING, INSOFAST, LLC MAKES NO WARRANTY, EXPRESSED OR IMPLIED. INSOFAST, LLC ASSUMES NO LEGAL LIABILITY OR RESPONSIBILITY FOR THE ACCURACY, COMPLETENESS, OR USEFULNESS OR ANY INFORMATION APPARATUS, PRODUCT OR PROCESS DISCLOSED.



Window Detail - CMU - Return with FRP

888-501-7899

InSoFast, LLC

www.InSoFast.com

Scale: NOT TO SCALE

Date: March 2010

Detail #: **ISF 07.01.21**

ISF 07.01.06 INSOFast - WINDOW - CMU - DRYWALL RETURN OVER WOOD FRAMING

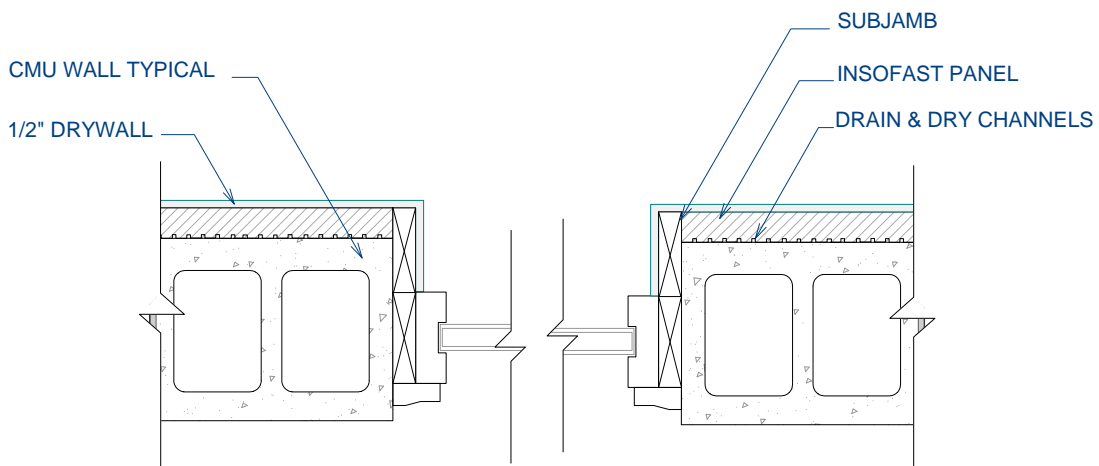
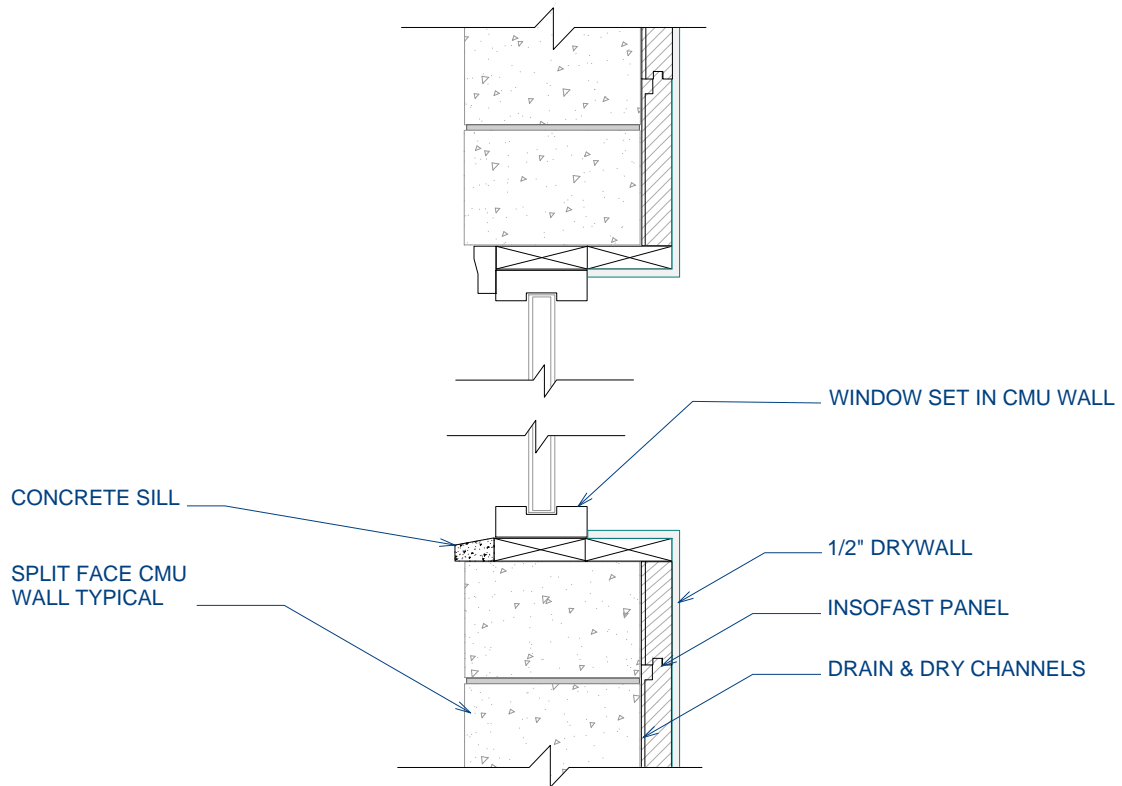

DUE TO VARIANCES IN LOCAL CODES, CONSTRUCTION PRACTICES, AND REQUIREMENTS, ALL DETAILS SHALL BE CONSTRUCTED IN ACCORDANCE WITH SUCH LOCAL CODES, CONSTRUCTION PRACTICES, AND REQUIREMENTS REGARDLESS OF DETAIL CONSTRUCTION SHOWN IN THIS DRAWING, INSOFast, LLC MAKES NO WARRANTY, EXPRESSED OR IMPLIED. INSOFast, LLC ASSUMES NO LEGAL LIABILITY OR RESPONSIBILITY FOR THE ACCURACY, COMPLETENESS, OR USEFULNESS OR ANY INFORMATION APPARATUS, PRODUCT OR PROCESS DISCLOSED.



Window - CMU - Drywall Return over Wood Framing

888-501-7899

InSoFast, LLC

www.InSoFast.com

Scale: NOT TO SCALE

Date: March 2010

Detail #: **ISF 07.01.06**

ISF 07.01.05 INSOFAST - WINDOW - CMU - DRYWALL RETURN OVER INSOFAST

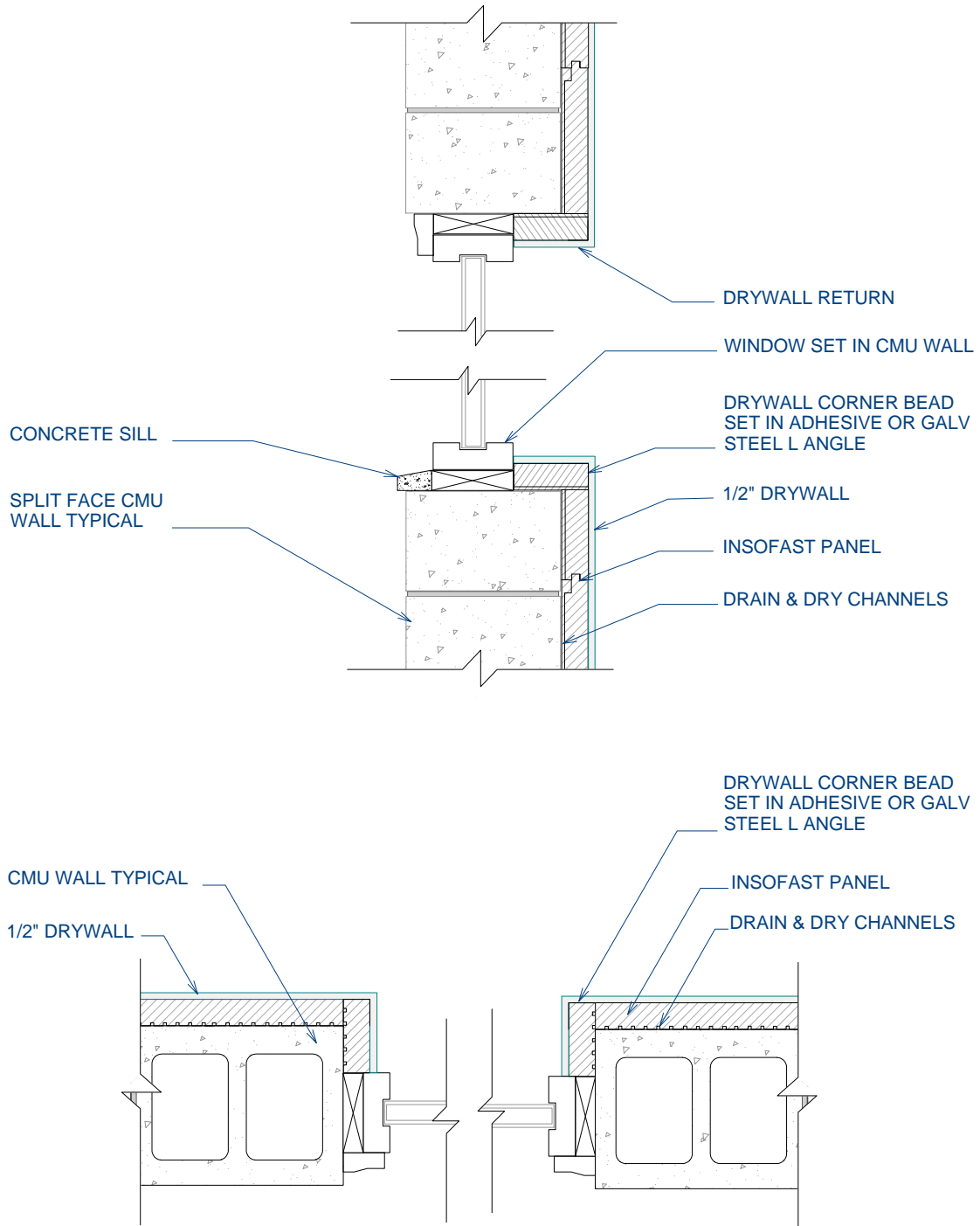

DUE TO VARIANCES IN LOCAL CODES, CONSTRUCTION PRACTICES, AND REQUIREMENTS, ALL DETAILS SHALL BE CONSTRUCTED IN ACCORDANCE WITH SUCH LOCAL CODES, CONSTRUCTION PRACTICES, AND REQUIREMENTS REGARDLESS OF DETAIL CONSTRUCTION SHOWN IN THIS DRAWING, INSOFAST, LLC MAKES NO WARRANTY, EXPRESSED OR IMPLIED. INSOFAST, LLC ASSUMES NO LEGAL LIABILITY OR RESPONSIBILITY FOR THE ACCURACY, COMPLETENESS, OR USEFULNESS OR ANY INFORMATION APPARATUS, PRODUCT OR PROCESS DISCLOSED.



Window - CMU - Drywall Return over InSoFast

888-501-7899

InSoFast, LLC

www.InSoFast.com

Scale: NOT TO SCALE

Date: March 2010

Detail #: **ISF 07.01.05**

ISF 07.01.08 INSOFAST - WINDOW - CMU - WOOD EXTENSION JAMB & TRIM WITH SOLID BACKING

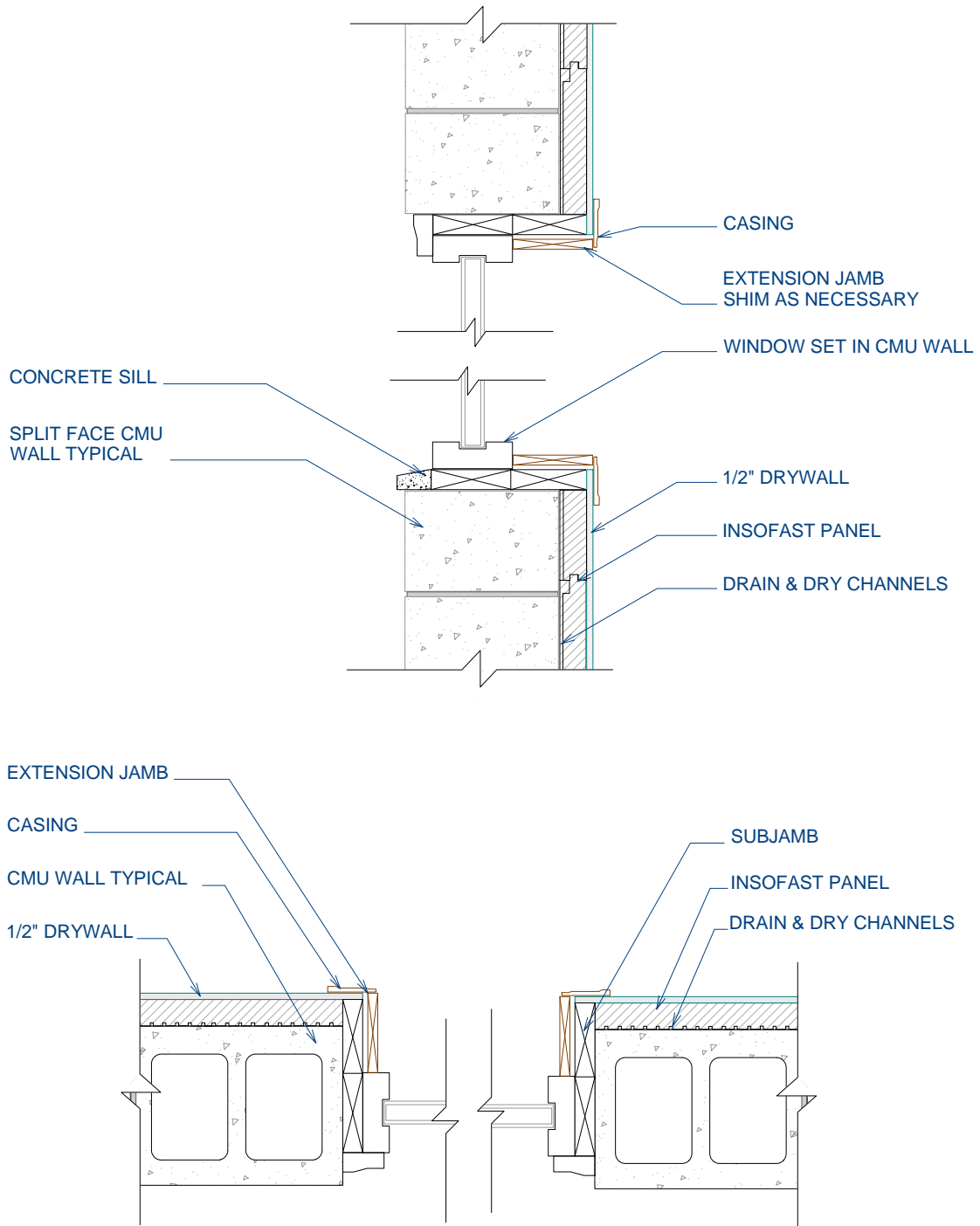

DUE TO VARIANCES IN LOCAL CODES, CONSTRUCTION PRACTICES, AND REQUIREMENTS, ALL DETAILS SHALL BE CONSTRUCTED IN ACCORDANCE WITH SUCH LOCAL CODES, CONSTRUCTION PRACTICES, AND REQUIREMENTS REGARDLESS OF DETAIL CONSTRUCTION SHOWN IN THIS DRAWING, INSOFAST, LLC MAKES NO WARRANTY, EXPRESSED OR IMPLIED. INSOFAST, LLC ASSUMES NO LEGAL LIABILITY OR RESPONSIBILITY FOR THE ACCURACY, COMPLETENESS, OR USEFULNESS OR ANY INFORMATION APPARATUS, PRODUCT OR PROCESS DISCLOSED.



Window - CMU - Wood Extension Jamb & Trim with Solid Backing

888-501-7899

InSoFast, LLC

www.InSoFast.com

Scale: NOT TO SCALE

Date: March 2010

Detail #: **ISF 07.01.08**

ISF 07.01.08 INSOFast - WINDOW - CMU - WOOD EXTENSION JAMB & TRIM

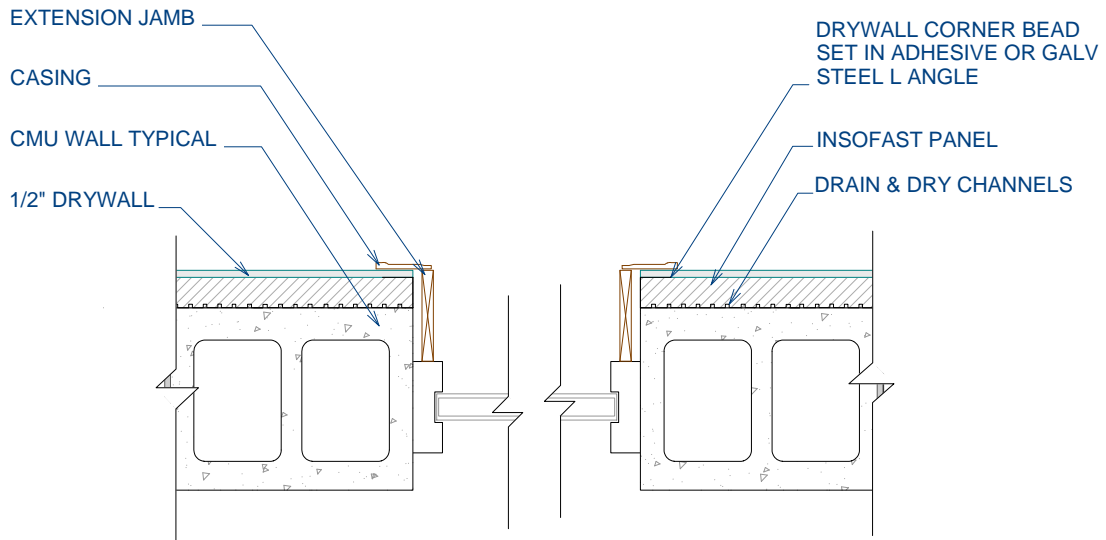
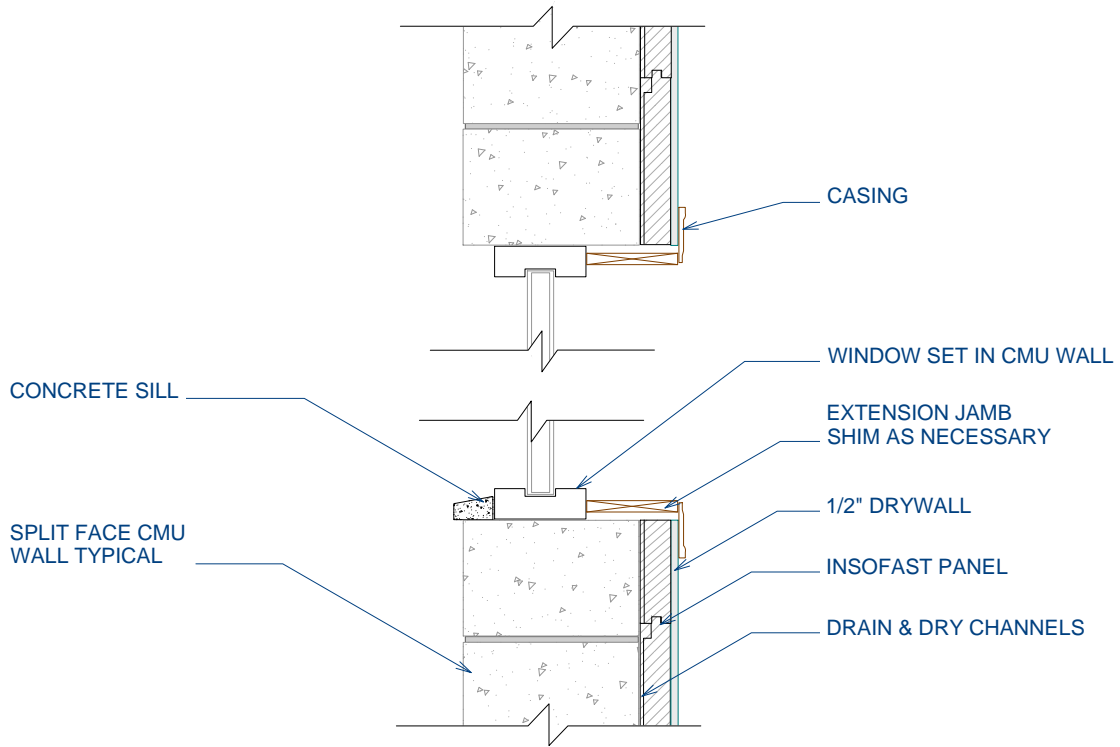

DUE TO VARIANCES IN LOCAL CODES, CONSTRUCTION PRACTICES, AND REQUIREMENTS, ALL DETAILS SHALL BE CONSTRUCTED IN ACCORDANCE WITH SUCH LOCAL CODES, CONSTRUCTION PRACTICES, AND REQUIREMENTS REGARDLESS OF DETAIL CONSTRUCTION SHOWN IN THIS DRAWING, INSOFast, LLC MAKES NO WARRANTY, EXPRESSED OR IMPLIED. INSOFast, LLC ASSUMES NO LEGAL LIABILITY OR RESPONSIBILITY FOR THE ACCURACY, COMPLETENESS, OR USEFULNESS OR ANY INFORMATION APPARATUS, PRODUCT OR PROCESS DISCLOSED.



Window - CMU - Wood Extension Jamb & Trim over Wood

888-501-7899

InSoFast, LLC

www.InSoFast.com

Scale: NOT TO SCALE

Date: March 2010

Detail #: **ISF 07.01.09**

**ISF 07.01.25 INSOFAST - DOOR - CMU - FULL WIDTH STEEL JAMB -
FIBER REINFORCED PANEL (FRP) FINISH**

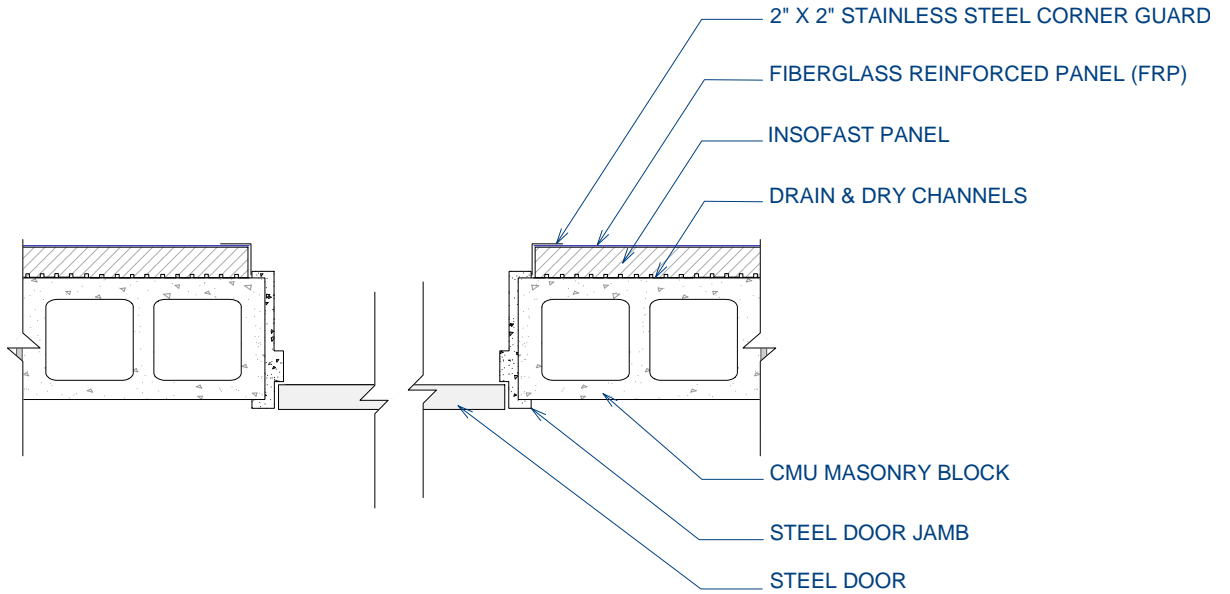

* 18 GA #304 STAINLESS STEEL CORNER GUARD
AVAILABLE THROUGH: WWW.FRPSHOP.COM

DUE TO VARIANCES IN LOCAL CODES, CONSTRUCTION PRACTICES, AND REQUIREMENTS, ALL DETAILS SHALL BE CONSTRUCTED IN ACCORDANCE WITH SUCH LOCAL CODES, CONSTRUCTION PRACTICES, AND REQUIREMENTS REGARDLESS OF DETAIL CONSTRUCTION SHOWN IN THIS DRAWING, INSOFAST, LLC MAKES NO WARRANTY, EXPRESSED OR IMPLIED. INSOFAST, LLC ASSUMES NO LEGAL LIABILITY OR RESPONSIBILITY FOR THE ACCURACY, COMPLETENESS, OR USEFULNESS OR ANY INFORMATION APPARATUS, PRODUCT OR PROCESS DISCLOSED.



Door - CMU - Full Width Steel Jamb - FRP Finish

888-501-7899

InSoFast, LLC

www.InSoFast.com

Scale: NOT TO SCALE

Date: March 2010

Detail #: **ISF 07.01.25**

ISF 07.01.26 INSOFAST - DOOR - CMU - INSET STEEL JAMB - FIBER REINFORCED PANEL (FRP) RETURN

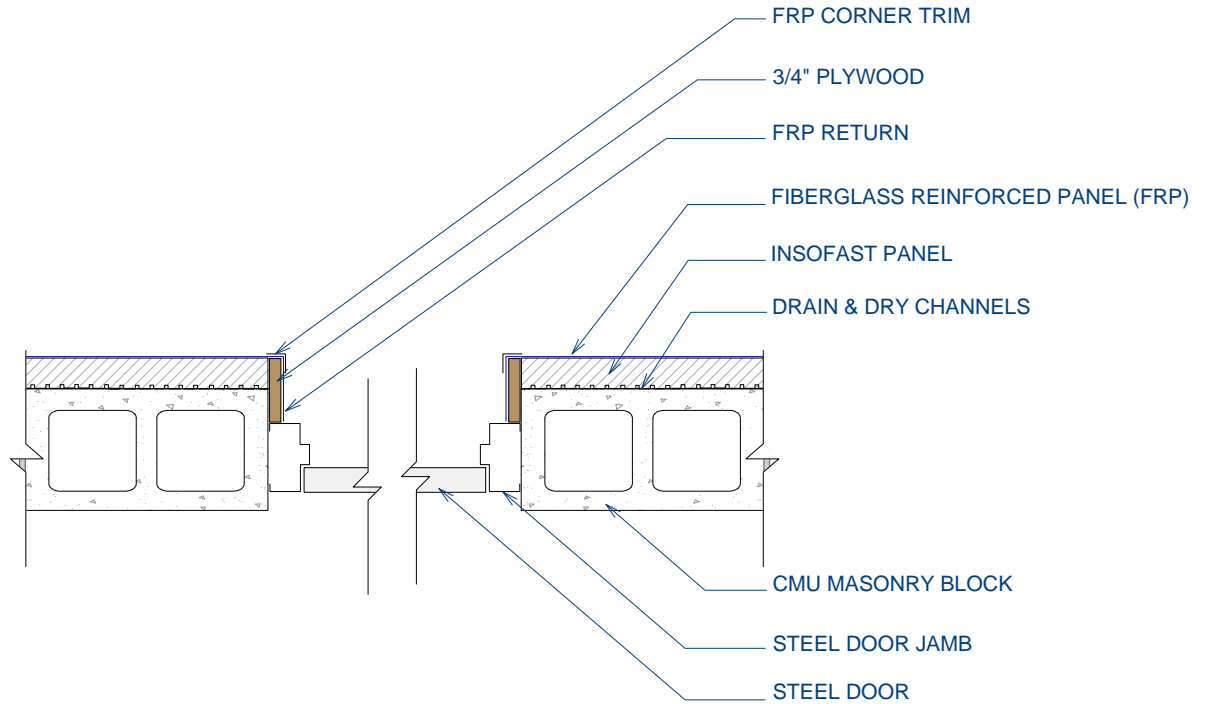

DUE TO VARIANCES IN LOCAL CODES, CONSTRUCTION PRACTICES, AND REQUIREMENTS, ALL DETAILS SHALL BE CONSTRUCTED IN ACCORDANCE WITH SUCH LOCAL CODES, CONSTRUCTION PRACTICES, AND REQUIREMENTS REGARDLESS OF DETAIL CONSTRUCTION SHOWN IN THIS DRAWING, INSOFAST, LLC MAKES NO WARRANTY, EXPRESSED OR IMPLIED. INSOFAST, LLC ASSUMES NO LEGAL LIABILITY OR RESPONSIBILITY FOR THE ACCURACY, COMPLETENESS, OR USEFULNESS OR ANY INFORMATION APPARATUS, PRODUCT OR PROCESS DISCLOSED.



Door - CMU - Inset Steel Jamb - FRP Return

888-501-7899

InSoFast, LLC

www.InSoFast.com

Scale: NOT TO SCALE

Date: March 2010

Detail #: **ISF 07.01.26**

ISF 08.01.01 INSOFAST - ELECTRICAL - UTILIZING WIRING CHASES

TO LOCATE ELECTRICAL BOXES WITHIN THE FIELD OF THE PANEL, PLACE WIRING WITHIN CLOSEST CHASE. CUT OUT FOR ELECTRICAL BOX, CUT OUT THE AREA UP TO THE CHASE. INSTALL BOX, RUN WIRING, REPLACE FOAM PIECE, AND GLUE IN PLACE.

WIRING CAN BE RUN IN THE VERTICAL WIRING CHASES AND THEN INTO THE CEILING

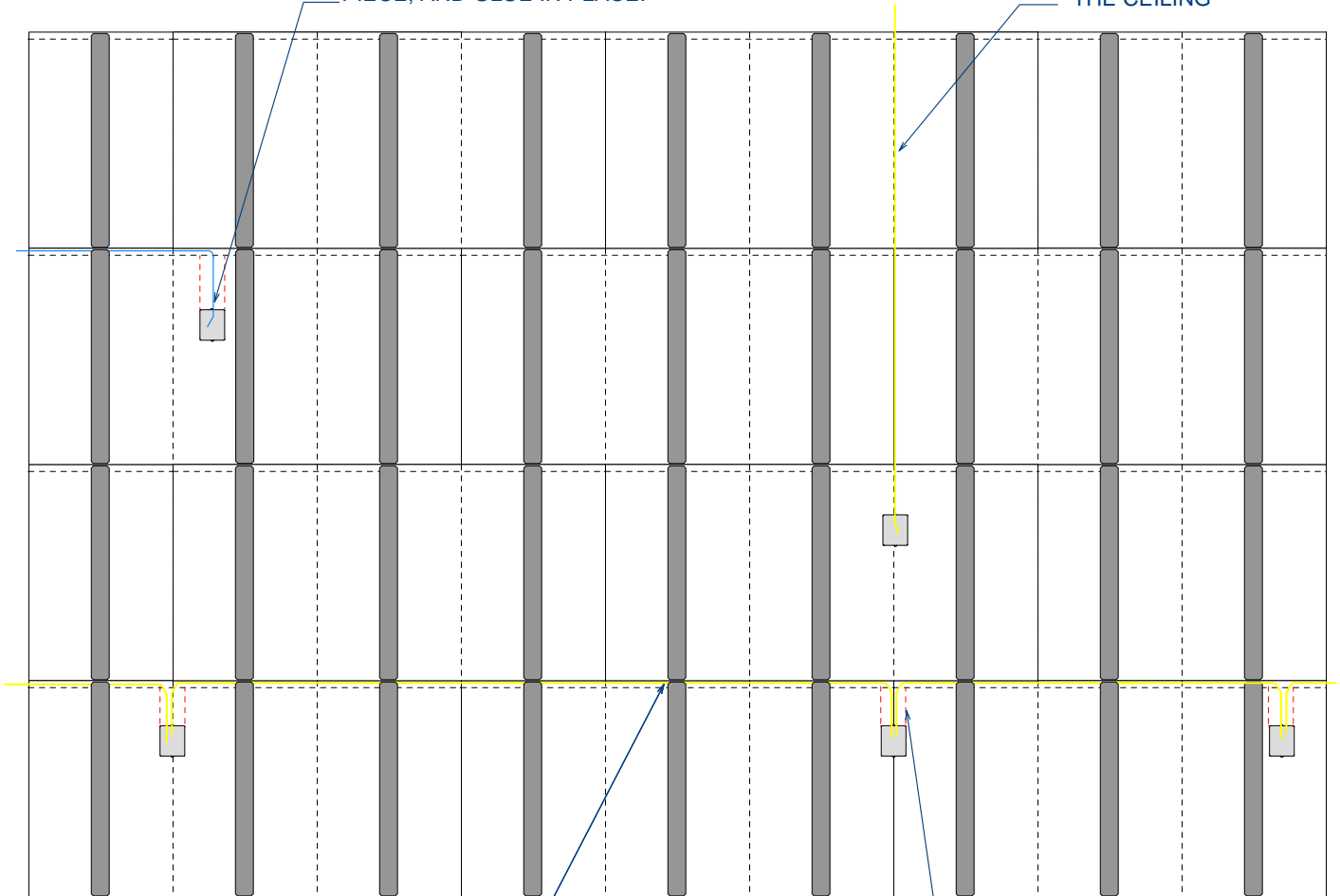

WIRING CAN BE RUN IN THE HORIZONTAL WIRING CHASES FROM BOX TO BOX

CUT OUT FOAM FOR BOX, INCLUDING FOAM UP TO HORIZONTAL CHASE. RUN WIRING AND GLUE FOAM PIECE BACK IN ABOVE ELECTRICAL BOX.

DUE TO VARIANCES IN LOCAL CODES, CONSTRUCTION PRACTICES, AND REQUIREMENTS, ALL DETAILS SHALL BE CONSTRUCTED IN ACCORDANCE WITH SUCH LOCAL CODES, CONSTRUCTION PRACTICES, AND REQUIREMENTS REGARDLESS OF DETAIL CONSTRUCTION SHOWN IN THIS DRAWING, INSOFAST, LLC MAKES NO WARRANTY, EXPRESSED OR IMPLIED. INSOFAST, LLC ASSUMES NO LEGAL LIABILITY OR RESPONSIBILITY FOR THE ACCURACY, COMPLETENESS, OR USEFULNESS OR ANY INFORMATION APPARATUS, PRODUCT OR PROCESS DISCLOSED.



Electrical - Utilizing Wiring Chases

888-501-7899

InSoFast, LLC

www.InSoFast.com

Scale: NOT TO SCALE

Date: March 2010

Detail #: **ISF 08.01.01**

ISF 09.01 INSOFAST - CORNER BEAD DETAIL FOR DRYWALL

INSTALL INSOFAST PANELS IN A RUNNING BOND. AT CORNER, ADD 2" TO THE CUT LENGTH. USE CUT OFF PIECE TO CONTINUE AROUND THE CORNER.

INSTALL 2" METAL CORNER TRIM WITH FOAM COMPATIBLE ADHESIVE. ALLOW TO DRY 24 HOURS BEFORE INSTALLING DRYWALL.

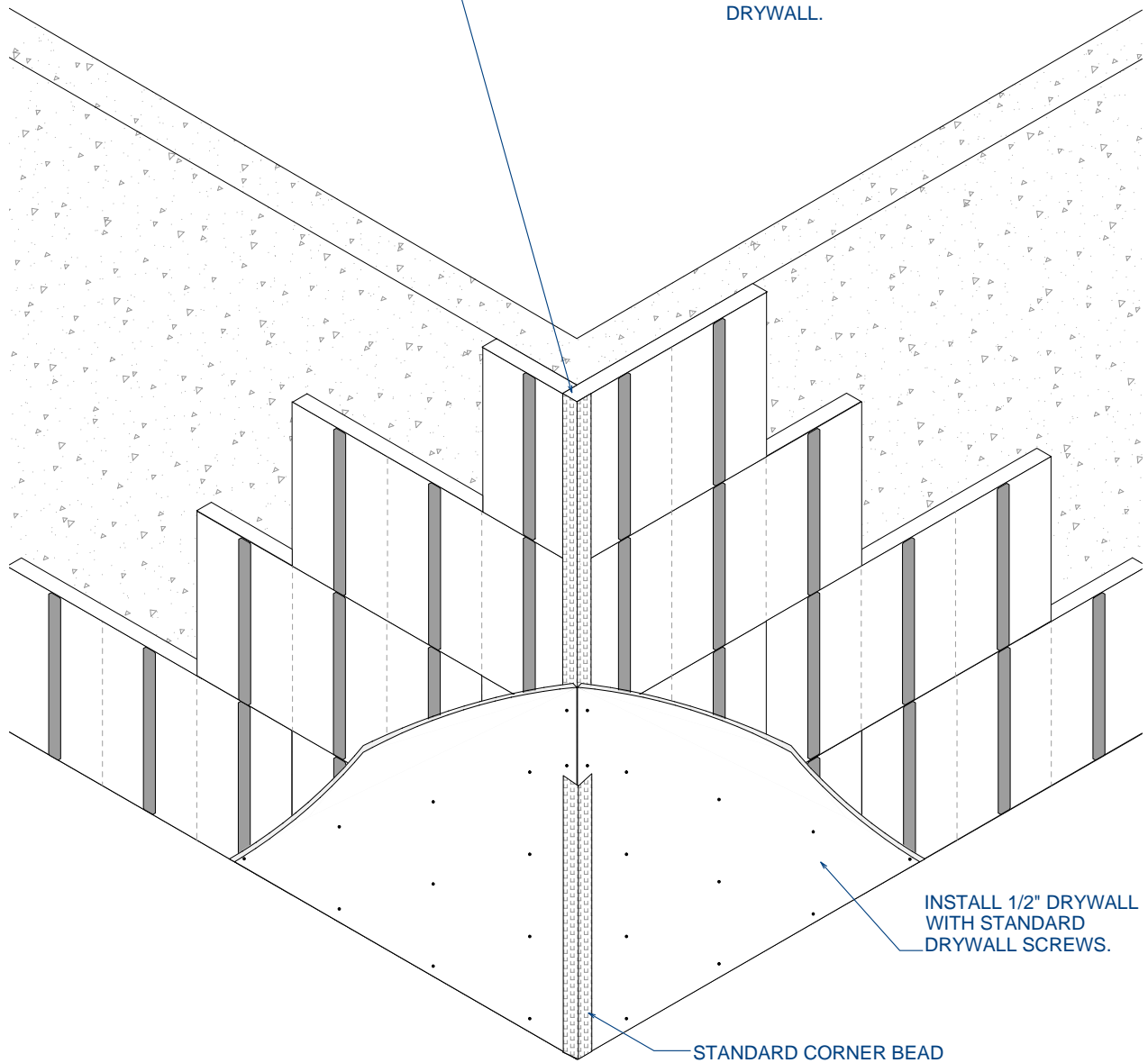

DUE TO VARIANCES IN LOCAL CODES, CONSTRUCTION PRACTICES, AND REQUIREMENTS, ALL DETAILS SHALL BE CONSTRUCTED IN ACCORDANCE WITH SUCH LOCAL CODES, CONSTRUCTION PRACTICES, AND REQUIREMENTS REGARDLESS OF DETAIL CONSTRUCTION SHOWN IN THIS DRAWING, INSOFAST, LLC MAKES NO WARRANTY, EXPRESSED OR IMPLIED. INSOFAST, LLC ASSUMES NO LEGAL LIABILITY OR RESPONSIBILITY FOR THE ACCURACY, COMPLETENESS, OR USEFULNESS OR ANY INFORMATION APPARATUS, PRODUCT OR PROCESS DISCLOSED.



Corner Bead Detail for Drywall

888-501-7899

InSoFast, LLC

www.InSoFast.com

Scale: NOT TO SCALE

Date: March 2010

Detail #: **ISF 09.01**